

BROMIC[®]
PLUMBING & GAS

Better with Bromic.

HOSE CONNECTIONS



HOSE CONNECTIONS

Trusted by Trade™, Bromic gas and water hoses are available in a vast variety of lengths, materials and connection types. Our hoses offer reliability and affordability, with all Bromic gas hoses having the Australian Gas Association (AGA) approval and water hoses with WaterMark approval.

Bromic gas and water hoses are available in standard lengths ranging from 200mm up to 3000mm with non-standard lengths available as a custom order (MOQ's apply). With hoses manufactured from high-quality PVC, rubber & braided stainless-steel we have an array of industry standard hose connections available.



Hose Specification Details	4-5
Hose Ordering Requirements	4
Non-standard Lengths (Key Information)	4
Non-Standard Fitting Combinations (Key Information)	4
Bromic Gas Hose Assemblies	5
Industry Thread Acronyms	5
PVC Gas Hoses	6 - 9
10mm PVC Gas Hoses	10 - 11
Rubber Gas Hoses	12 - 13
10mm Stainless Steel Gas Hoses	14
10mm Braided Stainless Steel Gas Hoses	15 - 21
13mm Braided Stainless Steel Gas Hoses	22
19mm Braided Stainless Steel Gas Hoses	22
25mm Braided Stainless Steel Gas Hoses	22
Bromic Pigtail Assemblies	23
Flexible Stainless Steel Pigtail Assemblies	24 - 25
Water Hose Connection Details	26
Pex Pro Water Hoses	28
Pex Core Water Hoses	29
Pex Core Mixer Tap Hoses	30
Quicky Water Hoses	31
Supply Water Hoses	32
Warranties & Extras	33

GAS HOSE SPECIFICATIONS

Hose Ordering Requirements

Gas and water hoses listed in this catalogue are considered to be stocked items. Bromic manufactures alternate lengths and fitting combinations to suit specific customer requirements but suggest using standard lengths where practical.

Hose connections are designated by the following codes:	
Acronym	Meaning
FF	Female Flare
FC	Female Cone (inverted flare)
LHF	Left Hand Female
M	Male
MF	Male Flare
MU	Male Union

Non-standard Lengths (Key Information)

Hose lengths listed are considered standard and if a stocked hose is simply slightly longer than required, we would still suggest ordering a standard hose.

If a customised hose length is required, the following applies:

- Minimum order quantity = 10 pieces
- Order: POA (please contact our Customer Care Team to obtain pricing)

Non-Standard Fitting Combinations (Key Information)

Hose fitting combinations listed are considered standard. If customised combinations are required, please first ensure that a standard fitting combination could not be used with the aid of an adaptor. (Please note: compliance with Australian standards is the sole responsibility of the user)

If a customisable fitting combination is required, the following applies:

- Minimum order quantity = 25 pieces
- Order: POA (please contact our Customer Care Team to obtain pricing)

Industry Thread Acronyms

BSP – British Standard Thread Pipe

NPT – American National Standard Taper Pipe Thread

SAE – Society of Automotive Engineers

GAS HOSE SPECIFICATIONS

Bromic Gas Hose Assemblies

All Bromic gas hose assemblies are approved to **AS/NZS 1869** however the maximum length of hose that can be installed is determined by the following standards.

- **AS/NZS 1596** The storage and handling of LP Gas
- **AS/NZS 5601.1** Gas installations
- **AS/NZS 5601.2** Gas installation Caravan and boats
- **AS/NZS 2658** LP Gas - Portable and mobile appliances

Compliance with the Australian standard is the sole responsibility of the user. It is the responsibility of the authorised installer to ensure the installed hose length does not exceed the maximum length allowed for that installation.

Additional Lengths

Some hose assemblies are available in lengths not stated. Enquire with Customer Service on available standard lengths.

Bromic Gas Hose Classes

Refer to the Bromic Gas Hose class table to determine

- Application
- Working pressure
- Temperature range

Class	Typical Application	Max. Working Pressure @ 23°C +/- 2°C	Working Temperature Range
A	Low pressure appliance hose	14 kPa	-20°C to +65°C
B	Low pressure, high temperature appliance hose	14 kPa	-20°C to +125°C
C	High pressure appliance and gas tool hose	2600 kPa	-20°C to +65°C
D	High pressure, high temperature appliance and gas tool hose	2600 kPa	-20°C to +125°C
F	Flexible cylinder connectors (Pigtails)	2600 kPa	-20°C to +100°C

Table 1. Bromic Gas Hose Classes



BROMIC
PLUMBING & GAS

Better with Bromic.

PVC GAS HOSE CONNECTIONS

Bromic's range of Class C, 6mm and Class A, 10mm PVC gas hoses are manufactured with high quality brass fittings and a polyvinyl chloride (PVC) finish, providing extensive durability. Approved by the Australian Gas Association for use with gas.

6MM ORANGE PVC GAS HOSES

6mm Gas Hose Assemblies

CLASS C

- Class C Gas Hose
- AGA Approved
- High pressure, low temperature hose type
- Maximum working pressure 2600 kPa
- Working temperature -20°C to +65°C
- Application: Gas, Outdoor/BBQ
- Approved to AS/NZS 1869

Certifications



6mm PVC Gas Hose - 6HAA

Part No.	Description	Length	Box Qty	AGA Approval No.
6HAA0600		600mm	10	4237
6HAA0900	1/4" BSP M	900mm	10	4237
6HAA1200	x 1/4" BSP FC	1200mm	10	4237
6HAA1800		1800mm	10	4237

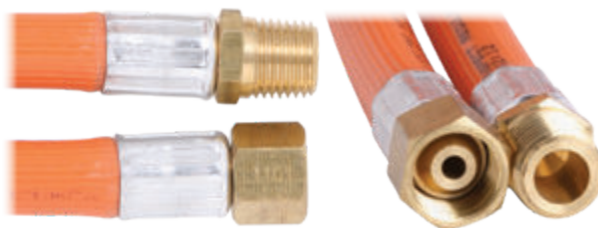

6mm PVC Gas Hose - 6HAB

Part No.	Description	Length	Box Qty	AGA Approval No.
6HAB0300		300mm	10	4237
6HAB0600		600mm	10	4237
6HAB0900		900mm	10	4237
6HAB1200	1/4" BSP FC	1200mm	10	4237
6HAB1800	x 1/4" BSP FC	1800mm	10	4237
6HAB2400		2400mm	10	4237
6HAB3000		3000mm	10	4237

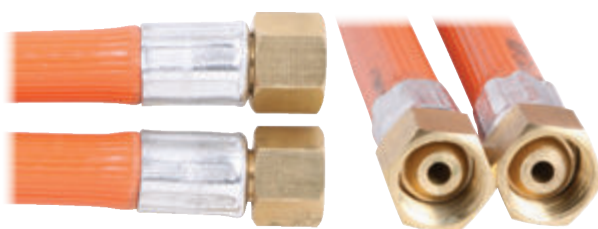

6mm PVC Gas Hose - 6HBB

Part No.	Description	Length	Box Qty	AGA Approval No.
6HBB0300		300mm	10	4237
6HBB0600		600mm	10	4237
6HBB0900	1/4" BSP FC	900mm	10	4237
6HBB1200	x 3/8" BSP M	1200mm	10	4237
6HBB1800		1800mm	10	4237
6HBB2400		2400mm	10	4237
6HBB3000		3000mm	10	4237



6MM ORANGE PVC GAS HOSES

6mm PVC Gas Hose - 6HCB

Part No.	Description	Length	Box Qty	AGA Approval No.
6HCB0300	5/16" SAE MF X 3/8" BSP M	300mm	10	4237
6HCB0450		450mm	10	4237
6HCB0600		600mm	10	4237
6HCB0900		900mm	10	4237
6HCB1200		1200mm	10	4237



6mm PVC Gas Hose - 6HCC

Part No.	Description	Length	Box Qty	AGA Approval No.
6HCC0300	5/16" SAE MF X 3/8" SAE FF	300mm	10	4237

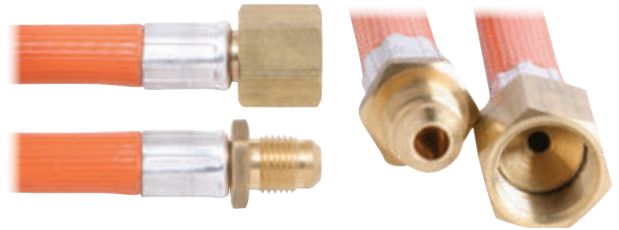

6mm PVC Gas Hose - 6HCK

Part No.	Description	Length	Box Qty	AGA Approval No.
6HCK0900	5/16" SAE MF X 5/16" SAE MF	900mm	10	4237

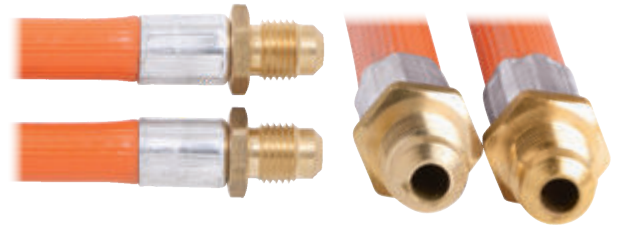

6mm PVC Gas Hose - 6HDB

Part No.	Description	Length	Box Qty	AGA Approval No.
6HDB0300	3/8" SAE MF X 3/8" BSP M	300mm	10	4237
6HDB0450		450mm	10	4237
6HDB0600		600mm	10	4237
6HDB0900		900mm	10	4237
6HDB1200		1200mm	10	4237



6mm PVC Gas Hose - 6HEB

Part No.	Description	Length	Box Qty	AGA Approval No.
6HEB0600	5/16" SAE FF X 5/16" SAE FF	600mm	10	4237
6HEB0900		900mm	10	4237
6HEB1200		1200mm	10	4237
6HEB1800		1800mm	10	4237

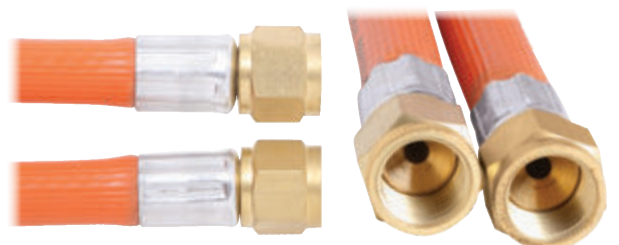

6mm PVC Gas Hose - 6HFB

Part No.	Description	Length	Box Qty	AGA Approval No.
6HFB0600	3/8" SAE FF X 3/8" SAE FF	600mm	10	4237
6HFB0900		900mm	10	4237
6HFB1200		1200mm	10	4237
6HFB1800		1800mm	10	4237



6MM ORANGE PVC GAS HOSES

6mm PVC Gas Hose - 6HGB

Part No.	Description	Length	Box Qty	AGA Approval No.
6HGB0600	3/8" SAE FF X 3/8" BSP M	600mm	10	4237
6HGB0900		900mm	10	4237
6HGB1200		1200mm	10	4237
6HGB1800		1800mm	10	4237
6HGB2400		2400mm	10	4237
6HGB3000		3000mm	10	4237

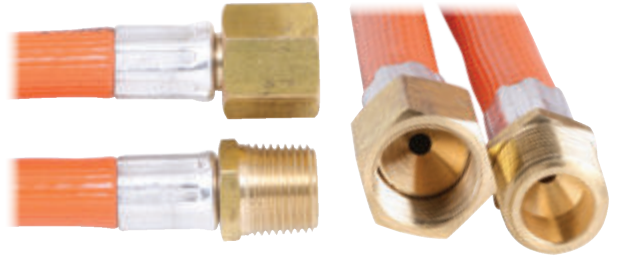

6mm PVC Gas Hose - 6HHC

Part No.	Description	Length	Box Qty	AGA Approval No.
6HHC0300	3/8" SAE MF X 3/8" SAE FF	300mm	10	4237

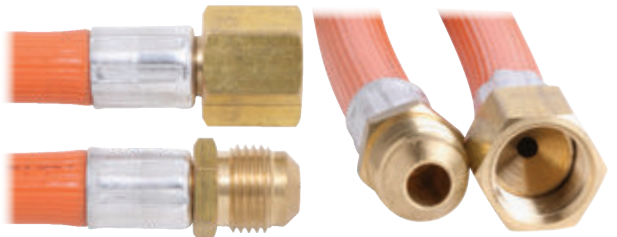

6mm PVC Gas Hose - 6HJR

Part No.	Description	Length	Box Qty	AGA Approval No.
6HJR0900	5/16" SAE FF X 3/8" BSP M	900mm	10	4237
6HJR1200		1200mm	10	4237
6HJR1800		1800mm	10	4237

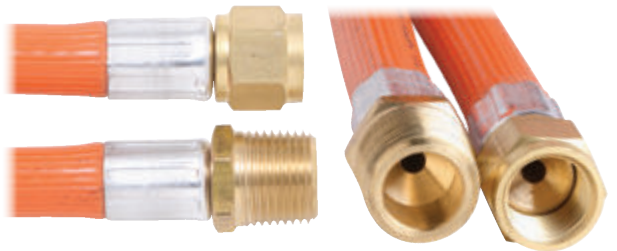

6mm PVC Gas Hose - 6HRB

Part No.	Description	Length	Box Qty	AGA Approval No.
6HRB0600	3/8" BSP FF X 3/8" BSP M	600mm	10	4237
6HRB0900		900mm	10	4237
6HRB1200		1200mm	10	4237
6HRB1800		1800mm	10	4237
6HRB2400		2400mm	10	4237
6HRB3000		3000mm	10	4237

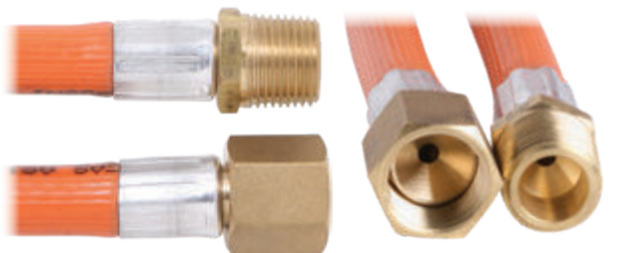

6mm PVC Gas Hose - 6HRC

Part No.	Description	Length	Box Qty	AGA Approval No.
6HRC0600	3/8" BSP FF X 3/8" BSP FF	600mm	10	4237
6HRC1200		1200mm	10	4237
6HRC1800		1800mm	10	4237



10MM PVC GAS HOSES

CLASS A

10mm Gas Hose Assemblies

- Class A Gas Hose
- Manufactured with high quality brass fittings and a polyvinyl chloride (PVC) hose
- AGA Approved
- Low pressure, low temperature hose type
- Maximum working pressure 14 kPa
- Working temperature -20°C to +65°C
- Approved to AS/NZS 1869

Certifications



10mm PVC Gas Hose - 10HBA

Part No.	Description	Length	Box Qty	AGA Approval No.
10HBA0200	1/2" BSP M x 3/8" SAE FF	200mm	10	4631
10HBA0600		600mm	10	4631

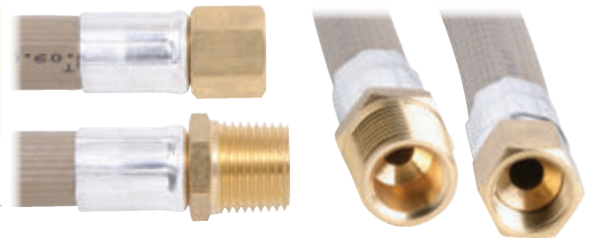

10mm PVC Gas Hose - 10HBE

Part No.	Description	Length	Box Qty	AGA Approval No.
10HBE0600	3/8" SAE FF x 3/8" SAE FF	600mm	10	4631
10HBE1200		1200mm	10	4631



10mm PVC Gas Hose - 10HBH

Part No.	Description	Length	Box Qty	AGA Approval No.
10HBH1200	3/8" BSP FF x 3/8" BSP FF	1200mm	10	4631



10mm PVC Gas Hose - 10HXX

Part No.	Description	Length	Box Qty	AGA Approval No.
10HXX1500	3/8" BSP FF	1500mm	10	4631
10HXX2000	x 3/8" BSP M	2000mm	10	4631
10HXX3000		3000mm	10	4631



10MM PVC BAYONET GAS HOSES

CLASS A

10mm Gas Heater Hose Assemblies

- Class A Gas Heater Hose
- Manufactured with high quality brass fittings and a polyvinyl chloride (PVC) hose
- AGA Approved
- Low pressure, low temperature hose type
- Maximum working pressure 14 kPa
- Working temperature -20°C to +65°C
- Approved to AS/NZS 1869

Certifications



10mm PVC Gas Heater Hose - 10HYB

Part No.	Description	Length	Box Qty	AGA Approval No.
10HYB1500	1/2" BSP FF x Male Bayonet	1500mm	10	4631
10HYB2000		2000mm	10	4631
10HYB3000		3000mm	10	4631



10mm PVC Gas Heater Hose - 10HYM

Part No.	Description	Length	Box Qty	AGA Approval No.
10HYM1500	1/2" BSP M x Male Bayonet	1500mm	10	4631
10HYM2000		2000mm	10	4631
10HYM3000		3000mm	10	4631

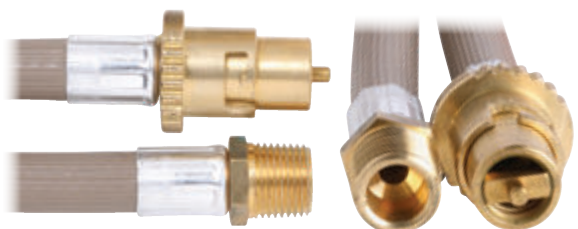

10mm PVC Gas Heater Hose - 10HEV

Part No.	Description	Length	Box Qty	AGA Approval No.
10HEV1500	3/8" BSP FF x Male Bayonet + Handle	1500mm	10	4631
10HEV3000		3000mm	10	4631

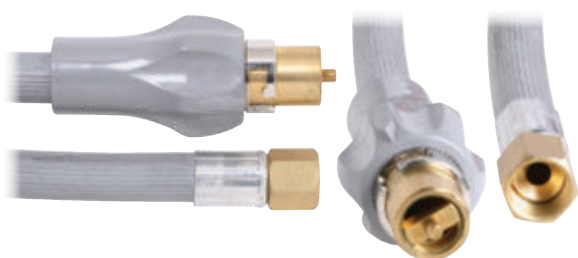

10mm PVC Gas Heater Hose - 10HZB

Part No.	Description	Length	Box Qty	AGA Approval No.
10HZB1500	3/8" BSP FF x Male Bayonet	1500mm	10	4631
10HZB2000		2000mm	10	4631
10HZB3000		3000mm	10	4631



10mm PVC Gas Heater Hose - 10HLP

Part No.	Description	Length	Box Qty	AGA Approval No.
10HLP1500-SAE	3/8" SAE F x Male Bayonet	1500mm	10	4631
10HLP2000-SAE		2000mm	10	4631
10HLP3000-SAE		3000mm	10	4631

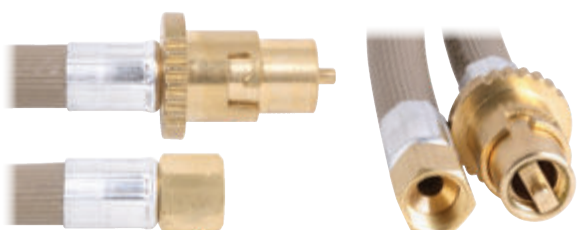



BROMIC
PLUMBING & GAS

Better with Bromic.

RUBBER GAS HOSE CONNECTIONS

Bromic's range of Class C, 6mm rubber gas hoses are manufactured with high quality brass fittings and a black rubber finish, providing extensive durability. Approved by the Australian Gas Association for use with gas.

6MM RUBBER GAS HOSES

6mm Gas Hose Assemblies

CLASS C

6mm Rubber Gas Hose - 6HTB

Part No.	Description	Length	Box Qty	AGA Approval No.
6HTB0900	1/4" BSP FC x 3/8" BSP-LHF	900mm	10	6420
6HTB1200		1200mm	10	6420
6HTB2000		2000mm	10	6420
6HTB4000		4000mm	10	6420
6HTB6000		6000mm	10	6420

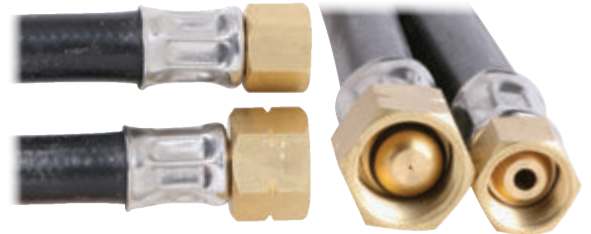

6mm Rubber Gas Hose - 6HSB

Part No.	Description	Length	Box Qty	AGA Approval No.
6HSB0600	M14 x 1 x 3/8" BSP-LHF	600mm	10	6420
6HSB0900		900mm	10	6420
6HSB1200		1200mm	10	6420
6HSB2000		2000mm	10	6420
6HSB4000		4000mm	10	6420
6HSB6000		6000mm	10	6420

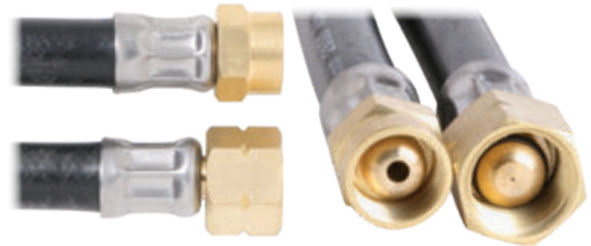

6mm Rubber Gas Hose - 6HLB

Part No.	Description	Length	Box Qty	AGA Approval No.
6HLB0600	M14 x 1 x 3/8" BSP-LHF	600mm	10	6420
6HLB0900		900mm	10	6420
6HLB1000		1000mm	10	6420
6HLB1200		1200mm	10	6420

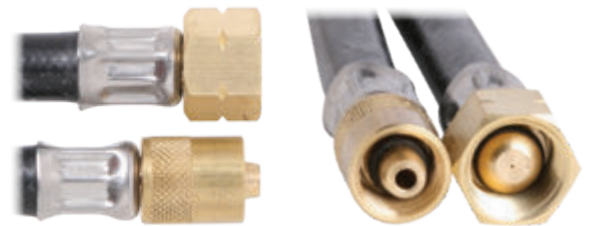

6mm Rubber Gas Hose - 6HKB

Part No.	Description	Length	Box Qty	AGA Approval No.
6HKB0600	M16 x 1.5 x 3/8" BSP-LHF	600mm	10	6420
6HKB0900		900mm	10	6420
6HKB1000		1000mm	10	6420
6HKB1200		1200mm	10	6420



6mm Rubber Gas Hose - 6HNB

Part No.	Description	Length	Box Qty	AGA Approval No.
6HNB0450	M16 x 1.5 + 0.22 INJ x 3/8" BSP-LHF	450mm	10	6420
6HNB0600		600mm	10	6420
6HNB0900		900mm	10	6420
6HNB1200		1200mm	10	6420



BROMIC
PLUMBING & GAS

Better with Bromic.



STAINLESS STEEL GAS HOSES

Bromic's range of stainless steel braided flexible gas hoses includes options for low and high pressure applications, available in a variety of diameters, lengths and connection types. Approved by the Australian Gas Association for use with gas.

10MM STAINLESS STEEL GAS HOSES

10mm Gas Hose Assemblies

- Class D Gas Hose
- AGA Approved
- High pressure, high temperature hose type
- Maximum working pressure 2600 kPa
- Working temperature -20°C to +125°C
- Application: kitchen, laundry, gas heaters
- Approved to AS/NZS 1869

CLASS D

Certifications



10mm Braided Stainless Steel Gas Hose - 10HAB

Part No.	Description	Length	Box Qty	AGA Approval No.
10HAB0300	1/2" SAE FF x 1/2" BSP M	300mm	10	5497
10HAB0450		450mm	10	5497
10HAB0600		600mm	10	5497
10HAB0900		900mm	10	5497
10HAB1200		1200mm	10	5497
10HAB1800		1800mm	10	5497

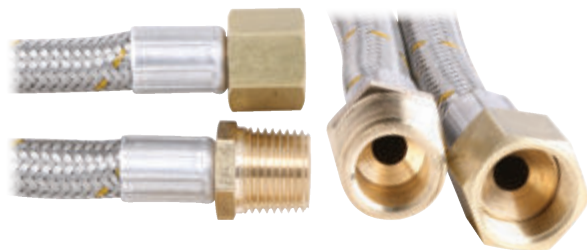

10mm Braided Stainless Steel Gas Hose - 10HAC

Part No.	Description	Length	Box Qty	AGA Approval No.
10HAC0600	1/2" SAE FF x 1/2" BSP FF	600mm	10	5497
10HAC0900		900mm	10	5497
10HAC1200		1200mm	10	5497

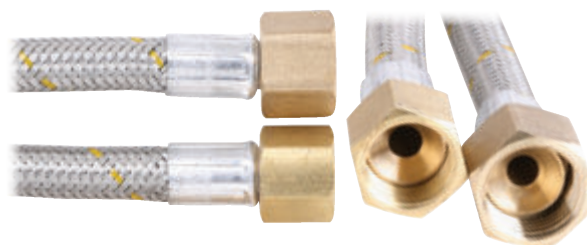

10mm Braided Stainless Steel Gas Hose - 10HAD

Part No.	Description	Length	Box Qty	AGA Approval No.
10HAD0600	1/2" SAE FF x 1/2" SAE FF	600mm	10	5497
10HAD0900		900mm	10	5497
10HAD1200		1200mm	10	5497
10HAD1800		1800mm	10	5497

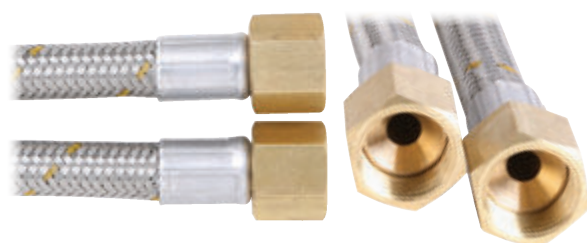

10mm Braided Stainless Steel Gas Hose - 10HBD

Part No.	Description	Length	Box Qty	AGA Approval No.
10HBD0600	3/8" BSP M x 1/2" BSP M	600mm	10	5497
10HBD1200		1200mm	10	5497
10HBD3000		3000mm	10	5497



10MM STAINLESS STEEL GAS HOSES

10mm Braided Stainless Steel Gas Hose - 10HDS

Part No.	Description	Length	Box Qty	AGA Approval No.
10HDS0300	1/2" BSP FF x 1/2" BSP FF	300mm	10	5497
10HDS0600		600mm	10	5497
10HDS0900		900mm	10	5497
10HDS1200		1200mm	10	5497
10HDS1500		1500mm	10	5497
10HDS1800		1800mm	10	5497
10HDS2400		2400mm	10	5497



10mm Braided Stainless Steel Gas Hose - 10HEK

Part No.	Description	Length	Box Qty	AGA Approval No.
10HEK1200	1/2" BSP M (loose nut) x 1/2" BSP FF	1200mm	10	5497
10HEK1700	1/2" BSP FF	1700mm	10	5497



10mm Braided Stainless Steel Gas Hose - 10HES

Part No.	Description	Length	Box Qty	AGA Approval No.
10HES1100	1/2" BSPT M x 3/8" BSP FF	1100mm	10	5497
10HES1700	3/8" BSP FF	1700mm	10	5497



10mm Braided Stainless Steel Gas Hose - 10HGA

Part No.	Description	Length	Box Qty	AGA Approval No.
10HGA2000	1/2" BSP M x 1/2" BSP M	2000mm	10	5497

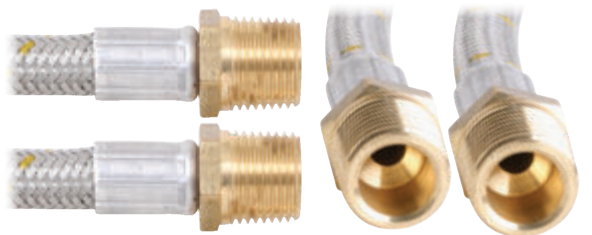

10mm Braided Stainless Steel Gas Hose - 10HPH

Part No.	Description	Length	Box Qty	AGA Approval No.
10HPH0300	1/2" BSP FC x 1/2" BSP FC	300mm	10	5497
10HPH0450		450mm	10	5497
10HPH0600		600mm	10	5497
10HPH0900		900mm	10	5497
10HPH1200		1200mm	10	5497
10HPH1500		1500mm	10	5497
10HPH1800		1800mm	10	5497
10HPH2000		2000mm	10	5497
10HPH3000		3000mm	10	5497



10MM STAINLESS STEEL GAS HOSES

10mm Braided Stainless Steel Gas Hose - 10HGS

Part No.	Description	Length	Box Qty	AGA Approval No.
10HGS0900	1/2" BSP M x 1/2" BSP MU	900mm	10	5497
10HGS1200	1/2" BSP MU	1200mm	10	5497



10mm Braided Stainless Steel Gas Hose - 10HPM

Part No.	Description	Length	Box Qty	AGA Approval No.
10HPM0300	1/2" BSP FC x 1/2" BSP M	300mm	10	5497
10HPM0450		450mm	10	5497
10HPM0600		600mm	10	5497
10HPM0900		900mm	10	5497
10HPM1000		1000mm	10	5497
10HPM1200		1200mm	10	5497
10HPM1500		1500mm	10	5497
10HPM1800		1800mm	10	5497
10HPM2000		2000mm	10	5497
10HPM3000		3000mm	10	5497



10mm Braided Stainless Steel Gas Hose - 10HPS

Part No.	Description	Length	Box Qty	AGA Approval No.
10HPS0300	1/2" BSP FF x 1/2" BSP M	300mm	10	5497
10HPS0450		450mm	10	5497
10HPS0600		600mm	10	5497
10HPS0900		900mm	10	5497
10HPS1200		1200mm	10	5497
10HPS1800		1800mm	10	5497



10mm Braided Stainless Steel Gas Hose - 10HEF

Part No.	Description	Length	Box Qty	AGA Approval No.
10HEF1200	1/2" BSP M (loose nut) x 1/4" BSP M	1200mm	10	5497
10HEF1700	1/4" BSP M	1700mm	10	5497



10MM STAINLESS STEEL GAS HOSES

10mm Braided Stainless Steel Gas Hose - 10HKA

Part No.	Description	Length	Box Qty	AGA Approval No.
10HKA0450	3/8" BSP FF x 3/8" SAE FF	450mm	10	5497
10HKA0600		600mm	10	5497
10HKA0900		900mm	10	5497
10HKA1200		1200mm	10	5497
10HKA1800		1800mm	10	5497



10mm Braided Stainless Steel Gas Hose - 10HKS

Part No.	Description	Length	Box Qty	AGA Approval No.
10HKS0300	3/8" SAE FF x 3/8" SAE FF	300mm	10	5497
10HKS0450		450mm	10	5497
10HKS0600		600mm	10	5497
10HKS0900		900mm	10	5497
10HKS1200		1200mm	10	5497



10mm Braided Stainless Steel Gas Hose - 10HBD

Part No.	Description	Length	Box Qty	AGA Approval No.
10HBD0600	3/8" BSP M x 1/2" BSP M	600mm	10	5497
10HBD1200		1200mm	10	5497
10HBD3000		3000mm	10	5497



10mm Braided Stainless Steel Gas Hose - 10HST

Part No.	Description	Length	Box Qty	AGA Approval No.
10HST0200	3/8" SAE FF x 1/2" BSP M	200mm	10	5497
10HST0300		300mm	10	5497
10HST0400		400mm	10	5497
10HST0600		600mm	10	5497
10HST0900		900mm	10	5497
10HST1200		1200mm	10	5497
10HST1500		1500mm	10	5497
10HST1800		1800mm	10	5497
10HST3000		3000mm	10	5497

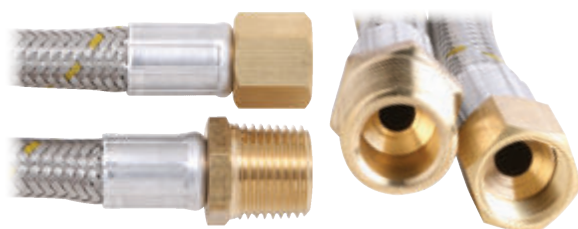

10MM STAINLESS STEEL GAS HOSES

10mm Gas Hose Assemblies

CLASS B

Bromic's range of Class B, 10mm, and 19mm stainless steel gas hoses are manufactured with a high quality braid, providing extensive durability with a maximum working pressure of 14 kPa. Approved by the Australian Gas Association for use with gas.

- Class B Gas Hose
- AGA Approved
- Low pressure, high temperature hose type
- Maximum working pressure 14 kPa
- Working temperature -20°C to +125°C
- Application: Kitchen, laundry, gas heaters
- Approved to AS/NZS 1869

Certifications



10mm Braided Stainless Steel Bayonet Gas Hose - 10HCS

Part No.	Description	Length	Box Qty	AGA Approval No.
10HCS0300	1/2" BSPT M x Male Bayonet	300mm	10	5497
10HCS0600		600mm	10	5497
10HCS0900		900mm	10	5497
10HCS1200		1200mm	10	5497
10HCS1500		1500mm	10	5497

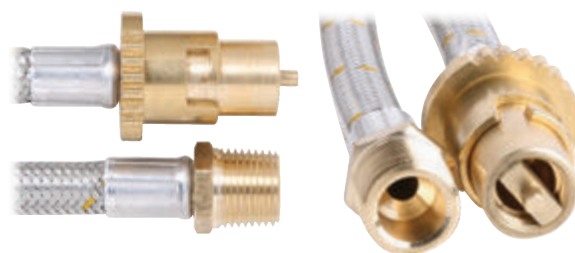

10mm Braided Stainless Steel Bayonet Gas Hose - 10HMS

Part No.	Description	Length	Box Qty	AGA Approval No.
10HMS0300	1/2" BSP FF x Male Bayonet	300mm	10	5497
10HMS0900		900mm	10	5497
10HMS1200		1200mm	10	5497



10mm Braided Stainless Steel Bayonet Gas Hose - 10HRS

Part No.	Description	Length	Box Qty	AGA Approval No.
10HRS0900	1/2" BSP FC x Male Bayonet	900mm	10	5497
10HRS1200		1200mm	10	5497
10HRS1800		1800mm	10	5497

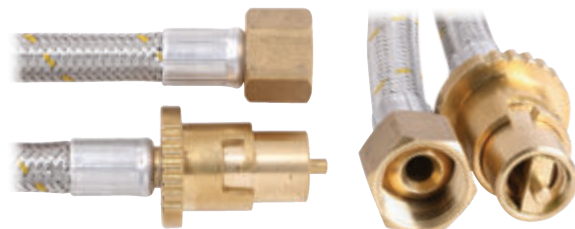

10MM STAINLESS STEEL GAS HOSES

10mm Braided Stainless Steel Bayonet Gas Hose - 10HEG

Part No.	Description	Length	Box Qty	AGA Approval No.
10HEG1200	1/2" BSP M x Male Bayonet	1200mm	10	5497
10HEG3000	(+ handle)	3000mm	10	5497

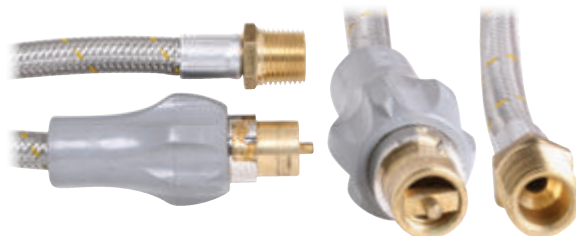

10mm Braided Stainless Steel Bayonet Gas Hose - 10HBS

Part No.	Description	Length	Box Qty	AGA Approval No.
10HBS1500	1/4" BSP M x Male Bayonet	1500mm	10	5497
10HBS2000		2000mm	10	5497
10HBS3000		3000mm	10	5497



10mm Braided Stainless Steel Bayonet Gas Hose - 10HTS

Part No.	Description	Length	Box Qty	AGA Approval No.
10HTS0600	1/4" BSP M x Male Bayonet	600mm	10	5497

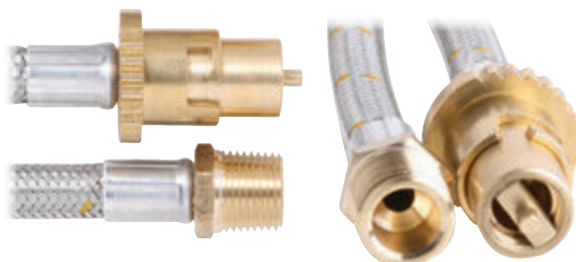

10mm Braided Stainless Steel Bayonet Gas Hose - 10HAS

Part No.	Description	Length	Box Qty	AGA Approval No.
10HAS1500	3/8" SAE FF x Male Bayonet	1500mm	10	5497
10HAS2000		2000mm	10	5497
10HAS3000		3000mm	10	5497



10mm Braided Stainless Steel Bayonet Gas Hose - 10HZS

Part No.	Description	Length	Box Qty	AGA Approval No.
10HZS1500	3/8" BSP FF x Male Bayonet	1500mm	10	5497
10HZS2000		2000mm	10	5497
10HZS3000		3000mm	10	5497



10MM STAINLESS STEEL GAS HOSES

10mm Braided Stainless Steel Gas Hose - 10HQS

Part No.	Description	Length	Box Qty	AGA Approval No.
10HQS0300	1/2" BSPT M x 1/4" BSP FC	300mm	10	5497
10HQS1500		1500mm	10	5497



10mm Braided Stainless Steel Gas Hose - 10HFG

Part No.	Description	Length	Box Qty	AGA Approval No.
10HFG0600	1/4" BSP FC x 1/4" BSP M	600mm	10	5497
10HFG1000		1000mm	10	5497
10HFG1500		1500mm	10	5497
10HFG3000		3000mm	10	5497



10mm Braided Stainless Steel Gas Hose - 10HSW

Part No.	Description	Length	Box Qty	AGA Approval No.
10HSW0300	1/4" BSP FC x 3/8" BSP M	300mm	10	5497
10HSW0900		900mm	10	5497
10HSW1000		1000mm	10	5497
10HSW1200		1200mm	10	5497
10HSW1500		1500mm	10	5497
10HSW1800		1800mm	10	5497
10HSW2000		2000mm	10	5497
10HSW3000		3000mm	10	5497



10mm Braided Stainless Steel Gas Hose - 10HFE

Part No.	Description	Length	Box Qty	AGA Approval No.
10HFE1000	3/8" BSP FF x 3/8" BSP M	1000mm	10	5497
10HFE1500		1500mm	10	5497

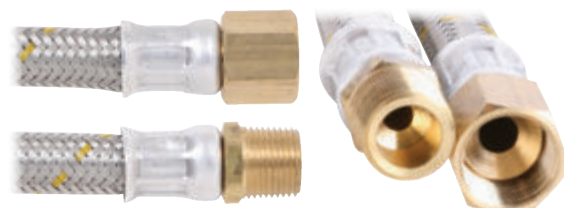

STAINLESS STEEL GAS HOSES

13mm Braided Stainless Steel Gas Hose - 13HCS

Part No.	Description	Length	Box Qty	AGA Approval No.
13HCS1000	1/2" BSPT M x Male Bayonet	1000mm	10	5497
13HCS1200		1200mm	10	5497
13HCS1500		1500mm	10	5497



13mm Braided Stainless Steel Gas Hose - 13HSC

Part No.	Description	Length	Box Qty	AGA Approval No.
13HSC0600	1/2" BSP FC x 1/2" BSP FC	600mm	10	5497
13HSC0900		900mm	10	5497
13HSC1200		1200mm	10	5497
13HSC1500		1500mm	10	5497



19mm Braided Stainless Steel Gas Hose - 19HSC

Part No.	Description	Length	Box Qty	AGA Approval No.
19HSC0450	3/4" BSP FC x 3/4" BSP FC	450mm	10	5497
19HSC0600		600mm	10	5497
19HSC0900		900mm	10	5497
19HSC1000		1000mm	10	5497
19HSC1200		1200mm	10	5497



19mm Braided Stainless Steel Gas Hose - 19HSU

Part No.	Description	Length	Box Qty	AGA Approval No.
19HSU0450	3/4" BSP FC x 3/4" BSP MU	450mm	10	5497
19HSU0600		600mm	10	5497
19HSU0900		600mm	10	5497
19HSU1200		1200mm	10	5497



19mm Braided Stainless Steel Gas Hose - 19HSM

Part No.	Description	Length	Box Qty	AGA Approval No.
19HSM0600	3/4" BSP FC x 3/4" BSP M	600mm	10	5497
19HSM0900		900mm	10	5497
19HSM1200		1200mm	10	5497
19HSM1500		1500mm	10	5497



Pigtail Assemblies

CLASS C

Bromic rubber Class C pigtail assemblies are manufactured in accordance with AS/NZS 1869 and approved by the Australian Gas Association for use with gas.

- Class C Gas Hose
- AGA Approved
- High pressure, low temperature hose type
- Maximum working pressure 2600 kPa
- Working temperature -20°C to +65°C
- Approved to AS/NZS 1869

Certifications



Flexible Rubber Pigtails - 6HPT

Part No.	Description	Length	Box Qty	AGA Approval No.
6HPT0450	7/16" Inverted Flare x POL	450mm	10	6409



Flexible Rubber Pigtails - 6HPTH

Part No.	Description	Length	Box Qty	AGA Approval No.
6HPTH450	7/16" Inverted Flare x Handwheel POL	450mm	10	6409



Copper Pigtails

Bromic 6mm copper pigtail assemblies are manufactured in accordance with AS/NZS 1869 and designed for use with LPG regulator connection to cylinders.

6mm Copper Pigtails

Part No.	Description	Length	Box Qty
6360510	7/16"-24 Inverted Flare x POL	450mm	25
6360511		600mm	10
6360514		750mm	10
6360512		1000mm	10

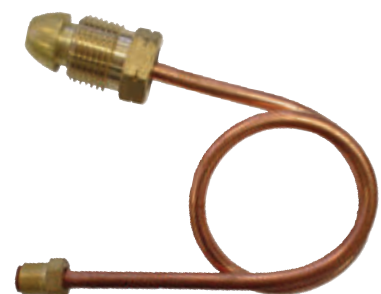

LCC27 PIGTAIL ASSEMBLIES

LCC27 Stainless Steel Pigtail Assemblies

CLASS F

Bromic flexible stainless steel Class F pigtail assemblies are also available with Type 27 (LCC27) connections, manufactured in accordance with AS/NZS 1869 and approved by the Australian Gas Association for use with gas.

- Class F Pigtail connector
- AGA Approved
- Maximum working pressure 2600 kPa
- Maximum hose length 600mm
- Working temperature -20°C to +100°C
- Approved to AS/NZS 1869

Certifications



LCC27 Braided Stainless Steel Pigtails - FLA

Part No.	Description	Length	Box Qty	AGA Approval No.
6LCC270450FLA	7/16" Inverted Flare x LCC27	450mm	10	6223
6LCC270600FLA		600mm	10	6223



LCC27 Braided Stainless Steel Pigtails - NPT

Part No.	Description	Length	Box Qty	AGA Approval No.
6LCC270450NPT	1/4" NPT M x LCC27	450mm	10	6223
6LCC270600NPT		600mm	10	6223



AGA approved Type 27 (LCC27) flexible hose assemblies for use on leisure LPG cylinders .

AGA approved Type 21 (POL) flexible hose assemblies for use on non-leisure LPG cylinders



FLEXIBLE PIGTAIL ASSEMBLIES

Flexible Stainless Steel Pigtail Assemblies

CLASS F

Bromic flexible stainless steel Class F pigtail assemblies are manufactured in accordance with AS/NZS 1869 and approved by the Australian Gas Association for use with gas.

- Class F Pigtail connector
- AGA Approved
- Maximum working pressure 2600 kPa
- Maximum hose length 600mm
- Working temperature -20°C to +100°C
- Approved to AS/NZS 1869

Certifications



Flexible Braided Stainless Steel Pigtails - 6SFN

Part No.	Description	Length	Box Qty	AGA Approval No.
6SFN0450*	7/16" Inverted Flare	450mm	10	6223
6SFN0600*	X POL	600mm	10	6223

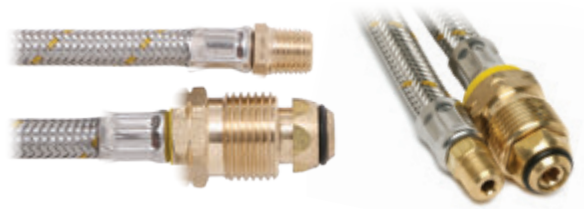

Flexible Braided Stainless Steel Pigtails - 6SHW

Part No.	Description	Length	Box Qty	AGA Approval No.
6SHW0450*	7/16" Inverted Flare	450mm	10	6223
6SHW0600*	X Handwheel POL	600mm	10	6223



*Pigtail needs to be assembled into regulator inlet with AC29 adaptor (5050420), 1/4" NPT M (into regulator) x 7/16"x24 NS F

Flexible Braided Stainless Steel Pigtails - 6SCA

Part No.	Description	Length	Box Qty	AGA Approval No.
6SCA0450	1/4" NPT M	450mm	10	6223
6SCA0600	X POL	600mm	10	6223

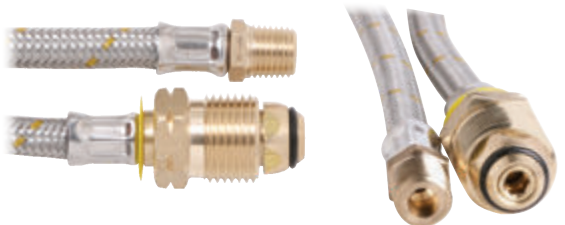

Flexible Braided Stainless Steel Pigtails - 6SCH

Part No.	Description	Length	Box Qty	AGA Approval No.
6SCH0450	1/4" NPT M	450mm	10	6223
6SCH0600	X Handwheel POL	600mm	10	6223





WATER HOSE CONNECTIONS

Our range of water hoses are WaterMarked in accordance with AS/NZS 3499, offer the option of a PEX or EPDM inner core covered with a marine grade 316 stainless steel braid.

WATER HOSE SPECIFICATION DETAILS

Water hose assembly is for indoor use only and to be installed away from UV light.

It is the responsibility of the installer to ensure the suitability of the water connector for the application and to ensure compliance with any government health codes and regulations.

Bromic water connectors are not to be installed within cavities, below ground or in any other inaccessible locations.

When installing, please ensure all threads and sealing surfaces are clean and dry. The installer must ensure all threads and sealing faces are de-burred and undamaged. Ensure the hose is not subject to abrasion and that the hose is not exposed to caustic or corrosive substances during installation (e.g. solder flux) and over the life of the product (e.g. cleaning products). Exposure to caustic or corrosive substances will void the Bromic warranty.

Refer to the hose label for the tightening requirements of the connector. Ensure not to over tighten the connector. The connector is also subjected to tensile or compressive force and must not be twisted or kinked.

During the installation the water hose assembly is to be installed free from kinks and excessive tight bends. For minimum bend radius (see Table 1). When installing the connector, ensure the bend radius is as large as possible where movement is possible.

DESCRIPTION			MINIMUM BEND RADIUS (EPDM Hose)					
ID mm	Max: Pressure (MPa)	Temperature	R	A	D (OD)	B	Z a=90°	Z a=180°
8	1.4	5°C to 70°C	25	25	13	20	140	190
10	1.4	5°C to 70°C	30	30	15	21.5	165	220
19	1.4	5°C to 70°C	55	5	27.5	35	290	396

Table 1: EPDM Hose installation requirements

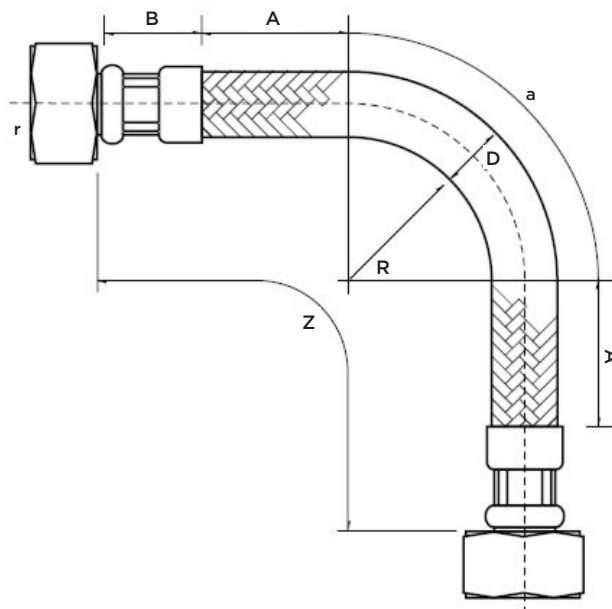

PEX CORE WATER HOSES

PEX PRO Water Hoses

Bromic 8mm PEX PRO™ water hoses are burst proof & rust proof guaranteed! Manufactured with our extremely high-density polyethylene PEX inner core, covered with a marine grade 316 stainless steel braid that is highly resistant to rust and corrosion. PEX PRO™ hoses meet the highest mechanical and hygiene standards, and are backed by an industry leading 15yr warranty.

The maximum working conditions for Bromic PEX Water Hoses connectors are as follows:

- Heated water +70°C @ 1000kPa
- Cold-water supplies 1200 kPa
- Rated working pressure not to exceed 1400kPa

Certifications



8mm PEX PRO Braided Stainless Steel Straight Water Hose - 8WSB

Part No.	Description	Length	Box Qty
8WSB0150-1	1/2" F x 1/2" F Straight PEX Core Water Hose	150mm	25
8WSB0225-1		225mm	25
8WSB0300-1		300mm	25
8WSB0450-1		450mm	25
8WSB0600-1		600mm	25
8WSB0750-1		750mm	25
8WSB1000-1		1000mm	25
8WSB1500-1		1500mm	25



8mm PEX PRO Braided Stainless Steel Elbow Water Hose - E8WSB

Part No.	Description	Length	Box Qty
E8WSB0150-1	1/2" F x 1/2" F Elbow PEX Core Water Hose	150mm	10
E8WSB0225-1		225mm	10
E8WSB0300-1		300mm	25
E8WSB0450-1		450mm	25
E8WSB0600-1		600mm	10
E8WSB0750-1		750mm	10



PEX Mixer Tap Hoses

Bromic 8mm PEX core water hoses are manufactured with our high-density polyethylene PEX inner core covered with a marine grade 316 stainless steel braid. WaterMarked in accordance with AS/NZS 3499, PEX hoses are more durable than standard EPDM hoses and meet the highest mechanical and hygiene standards, backed by a 15yr warranty.

The maximum working conditions for Bromic PEX Water Hoses connectors are as follows:

- Heated water +70°C @ 1000kPa
- Cold-water supplies 1200 kPa
- Rated working pressure not to exceed 1400kPa

Certifications



8mm PEX Core Braided Stainless Steel Water Hose Mixer Kit - 8WMF

Part No.	Description	Length	Box Qty
8WMF0150-1	1/2" F x 1/2" M PEX Core Mixer Tap Extension Kit	2x150mm	10 pairs
8WMF0225-1		2x225mm	10 pairs



8mm PEX Core Braided Stainless Steel Cold Mixer Tap Hose - 8WPM COLD

Part No.	Description	Length	Box Qty
8WPM0350C-1	1/2" F x M10 Cold PEX Core Mixer Tap Hose	350mm	25
8WPM0500C-1		500mm	25



8mm PEX Core Braided Stainless Steel Hot Mixer Tap Hose - 8WPM HOT

Part No.	Description	Length	Box Qty
8WPM0350H-1	1/2" F x M10 Hot PEX Core Mixer Tap Hose	350mm	25
8WPM0500H-1		500mm	25



8mm PEX Core Braided Stainless Steel Mixer Tap Hoses - 8WPM PAIR (1x HOT & 1x COLD)

Part No.	Description	Length	Bag Qty
8WPM0350P-1	1/2" F x M10 Hot PEX Core Mixer Tap Hoses (1x Hot & 1x Cold)	350mm	5
8WPM0500P-1		500mm	5



QUICKY WATER HOSES

Quicky Water Hoses

Bromic 'Quicky' stainless steel braided EPDM water hoses are manufactured with a rubber core covered with a stainless steel braid. WaterMarked in accordance with AS/NZS 3499.

The maximum working conditions for Bromic EPDM Water Hoses connectors are as follows:

- Maximum working temperature +70°C
- Maximum working pressure 1400 kPa

Certifications



8mm 'Quicky' Braided Stainless Steel Water Hose - 8WEB

Part No.	Description	Length	Box Qty
8WEB0225-1	1/2" F x 1/2" F Straight Connector	225mm	25
8WEB0300-1		300mm	25
8WEB0450-1		450mm	25
8WEB0600-1		600mm	25



19mm 'Quicky' Braided Stainless Steel Water Hose - 19WBB

Part No.	Description	Length	Box Qty
19WBB0300-1	3/4" F x 3/4" F Straight Connector	300mm	10
19WBB0450-1		450mm	10
19WBB0600-1		600mm	10
19WBB1000-1		1000mm	10



19mm 'Quicky' Braided Stainless Steel Water Hose - 19WBF

Part No.	Description	Length	Box Qty
19WBF0500-1	3/4" F x 3/4" F Flat Washer	500mm	10
19WBF1000-1		1000mm	10
19WBF1500-1		1500mm	10



Aqua Duct Universal PVC Extendable Drainage Hose

Part No. 5250020

Universal drainage hose suitable for use with most dishwashers & washing machines.

- 21/28mm connection (simply cut to size)
- Hose length 1200mm to 4000mm
- Polypropylene (PP)
- Suitable for hot & cold water
- Easy installation
- Box qty: 10



Aqua Duct PVC Supply Hose

Part No. 5250010

PVC supply hose suitable for use with most dishwashers & washing machines.

- 3/4" connection
- Hose length 2000mm
- Polypropylene (PP)
- Suitable for hot & cold water
- Easy installation
- Box qty: 10



Aqua Duct 10mm Stainless Steel Supply Hose

Part No. 5250065-1 (1500mm)
Part No. 5250060-1 (2000mm)

Stainless Steel supply hose suitable for use with most dishwashers & washing machines.

- 3/4" connection
- Braided stainless steel
- Suitable for hot & cold water
- Easy installation
- Box qty: 10



WARRANTIES & EXTRAS

All Bromic products are manufactured to the highest quality standard and come with guarantees against any material or workmanship defects; guarantees that cannot be excluded under Australian Consumer Law. For specific warranty details on any Bromic product, including warranty duration, please refer to the product instructions. Alternatively, contact our helpful customer service staff or visit bromicplumbing.com for more information.

IMAGES, SPECIFICATIONS

Due to the nature of the printing process, colours shown in this catalogue may differ from the actual colour of products. All images, drawings, graphics and design elements contained in this catalogue are subject to Australian and International copyright law. No part of this catalogue may be reproduced, copied or stored in part or whole without the prior written permission of Bromic Pty Ltd. Product details in this guide are indicative only and may change without notice, Bromic reserves the right to change specifications and any other information contained in this catalogue with no recourse from customers.

ORDERING

Orders can be placed by fax, online or email. Our catalogue includes Part No. to ensure ease of use, with the customer in mind.

COMPLIANCE

Products stocked by Bromic comply with all relevant regulatory requirements i.e. MEPS, AGA, electrical and safety requirements.

Australia & NZ

10 Phiney Place, Ingleburn
NSW 2565 Sydney AUSTRALIA

Visit **BROMICPLUMBING.COM**
email **plumbing@bromic.com**
or call **AU 1300 276 642 / NZ 0508 276 642**

