

BROMIC[®]
PLUMBING & GAS

Better with Bronic.

WATER SOLUTIONS

For Plumbing & Building Professionals



ABOUT US

With more than 40 years experience, Bromic are experts in the manufacture and supply of quality plumbing products.

Our hot water products offer energy efficient water heating on demand, with our 3 Phase instantaneous units ideal for multi-dwelling projects, and wall mounted boiling water units suitable for commercial applications.

Waterboy™ rainwater harvesting systems offer complete solutions for effective management of rainwater, with the ability to automatically supplement supply with mains water when needed for low-maintenance operation. Waterboy™ pumps also features a circulation pump and a diverse range of submersible pumps, including vortex sump pumps, sewage pumps and small submersibles for use with both dirty and potable water.

Our WaterMark-certified hoses (AS/NZS 3499) spans PEX and EPDM stainless steel braided options, as well as the advanced FlexPro™ PE-RT range with anti-corrosion braiding - all designed to meet the latest lead-free requirements.

Instant Hot Water	4 - 7
3 Phase Instantaneous Electric Hot Water	4 - 5
5L Compact Storage Electric Hot Water	6 - 7
Instant Boiling Water Dispensers	8 - 9
Waterboy™ Pumps	10 - 22
Hydro Switch™ Rains to Mains Valve & Pump Kits	10 - 11
Waterboy™ Jet Pumps	12
Waterboy™ Multi-Stage Pump	13
Waterboy™ Pressure Controller	14
Waterboy™ Circulation Pump	15
Waterboy™ Submersible Pumps	16 - 18
Waterboy™ Vortex Pumps	19 - 20
Waterboy™ Sewage Pumps	21 - 22
Water Hose	23 - 27
FLEXPRO™ 8mm Water Hoses	24
PEX PRO™ 8mm Water Hoses	25
PEX PRO™ 8mm Mixer Tap Hoses	26
Quicky 8mm Water Hoses	27
Air Admittance Valves	28
32-40-50mm Magic Valve	28
Warranties & Extras	29

ELECTRIC HOT WATER

3 Phase Electric Hot Water

The 3 Phase Instantaneous electric hot water heaters from Bromic are equipped with electronic control and clear LCD display. The 3-phase model supplies water to several water pick-ups, such as the kitchen and bathroom. The electronic water heater is rated 18kW / 21kW / 24kW / 27kW delivering instant hot water to suit your needs, with a temperature range between 30° to 60°C. The temperature lock allows the maximum temperature to be set, and the built in memory function stores the 3 most frequently used temperatures for easy selection. Available in 50°C and 60°C (Max. Temperature) configurations.

■ LCD Screen

- + Clearly displays desired outlet temperature.
- + Displays inlet and outlet water temperatures, the percentage of max. power the unit currently uses, and the water flow rate.

■ Electronic Control

- + Ensures stability and smooth regulation of the water temperature between 30° to 60°C. With 1°C steps.

■ Temperature Lock

- + Allows the user to set and save the maximum temperature value (Child safety lock).

■ Temperature Memory Function

- + Allows the user to save the 3 most frequently used water temperatures.

■ No Flue required

■ 50°C and 60°C (Max. Temperature) configurations available



Applications



Kitchen sink



Shower



Bath



Bathroom sink/basin



Certifications

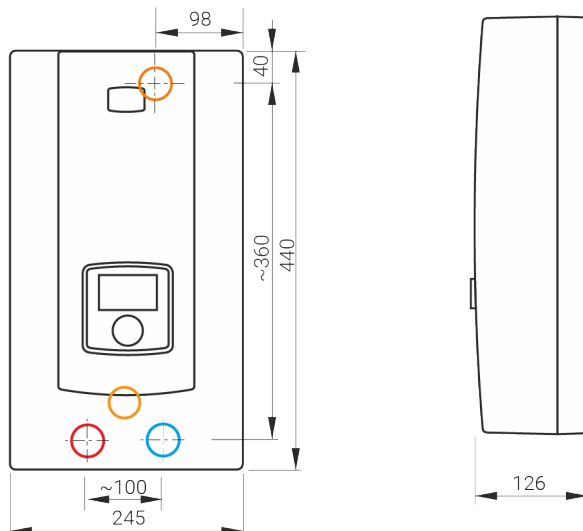

Dimensions



Inlet and outlet section G 1/2"

-  cold water inlet
-  hot water outlet
-  electric cable connection point

3 Phase Range Specifications

Model	HF-318	HF-321	HF-324	HF-327
Product No.	2850318	2850321	2850324	2850327
50°C Configured Product No.	2850318-S50	2850321-S50	2850324-S50	2850327-S50
Type	Instantaneous	Instantaneous	Instantaneous	Instantaneous
Voltage, V	415V	415V	415V	415V
Rated Power, kW	18	21	24	27
Rated Current, A	25.1	29.2	33.4	37.6
Hot Water Delivery, L/min (at $\Delta T = 35^{\circ}C$)	7.5	8.8	10	11.3
Min. Activation Flow Rate, L/min	2.5	2.5	2.5	2.5
Max Inlet Pressure Rating, kPa	1000	1000	1000	1000
Temperature Range [^] , °C	30° - 50/60°	30° - 50/60°	30° - 50/60°	30° - 50/60°
Dimensions (H x W x D) mm	440 x 245 x 126	440 x 245 x 126	440 x 245 x 126	440 x 245 x 126
Weight, kg	4	4	4	4
IP Rating	IP24	IP24	IP24	IP24
Water Connections	G 1/2" Female	G 1/2" Female	G 1/2" Female	G 1/2" Female
Element Type	Bare Element	Bare Element	Bare Element	Bare Element
Min Water Resistivity, Ω cm (at 15°C)	1100	1100	1100	1100
Pressure Range @ Main Water (MPa)	0.1 - 1	0.1 - 1	0.1 - 1	0.1 - 1
WaterMark Approval	WM 40268 (AS 3498)	WM 40268 (AS 3498)	WM 40268 (AS 3498)	WM 40268 (AS 3498)

[^]Available in 50°C & 60°C (Max. Temperature) configurations.

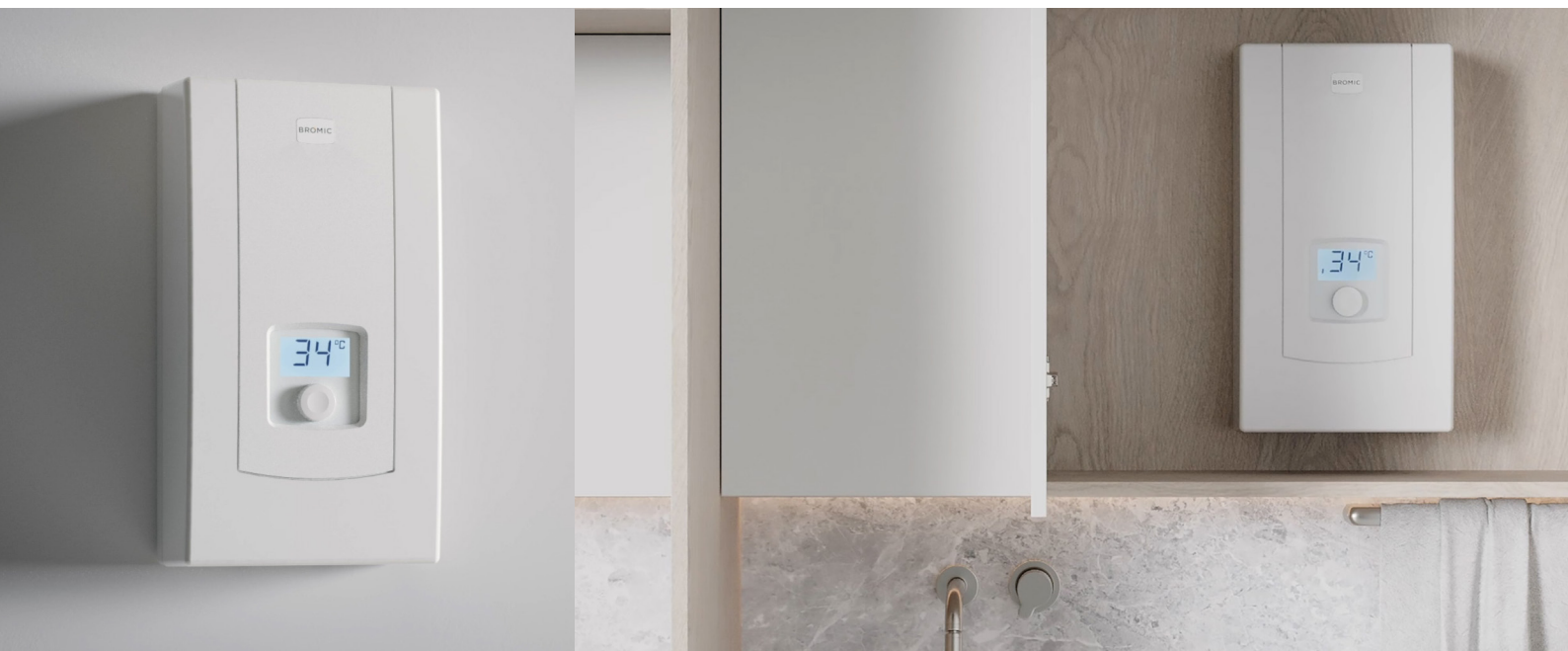

ELECTRIC HOT WATER

5L Compact Storage Electric Hot Water

Electronically controlled storage heater, with stainless steel tank designed to ensure quick and easy access to hot water. It is great for installation next to a sink in a laundry, bathroom, or kitchen. This electronic storage hot water heater is energy efficient and compact. The stainless-steel inner tank is resistant to corrosion, with a quick heating time of just 5.5min for a full tank.

- **Stainless Steel Tank**
 - + Resistant to corrosion.
 - + No need to change anode regularly.
- **Comfortable Temperature Control**
 - + With smooth temperature range between 23-70°C.
- **Energy Efficient**
 - + With very low energy losses
- **Under sink & over sink configurations available**
- **For single point of use/outlet**
- **Comes with vented tap. Also available as unit only**

Quick Heating Time



- With immersion heater of 2000W
- Heats 5L in 5.5min at 30°C temperature rise

Vented Mixer Tap



Bromic Vented Mixer Tap included with 5L Under Sink configuration (HF-UH5)



Applications



Kitchen sink



Bathroom sink/basin

Certifications



Pressurised connection to vented mixer tap provided.

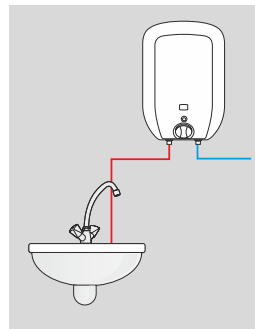

Over Sink

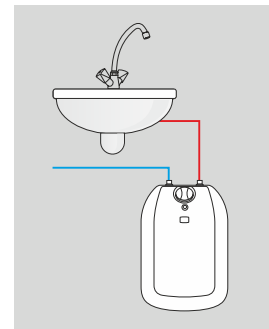

Under Sink

Dimensions

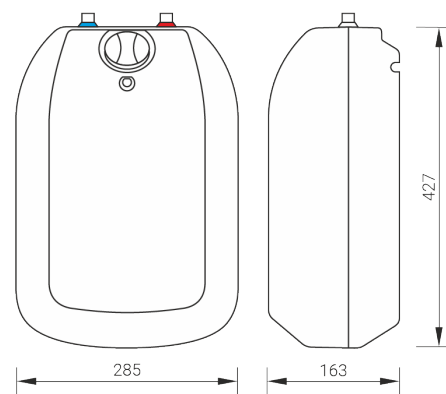

5L Range Specifications

Model	HF-UH5	HF-OH5
Product No.	2850001	2850002
Mount	Under Sink	Over Sink
Type	Vented Storage	Vented Storage
Voltage, V	240V	240V
Rated Power, kW	2	2
Rated Current, A	8.3 - 9.1	8.3 - 9.1
Max Inlet Pressure Rating, kPa	600	600
Temperature Range, °C	23° - 70°	23° - 70°
Dimensions (H x W x D) mm	427 x 285 x 163	427 x 285 x 163
Weight, kg	4.5	4.5
IP Rating	IP24	IP24
Water Connections	Cold = G 1/2" Male Hot = G 1/2" Male	Cold = G 1/2" Male Hot = G 1/2" Male
Tank Material	Stainless Steel	Stainless Steel
WaterMark Approval	WM 40268 (AS 3498)	WM 40268 (AS 3498)
Features	<ul style="list-style-type: none"> • Stainless steel tank • Pressurised system • Electronically controlled 	
Includes	1x 5L Underbench Electric Water Heater 1x Vented Mixer Tap 2x Brass Reducing Adaptors	1x 5L Overbench Electric Water Heater (Tap and Reducers will need to be purchased separately to make a complete kit)



INSTANT BOILING WATER

Instant Boiling Water Dispensers

- **Instant Access to Boiling Water**
 - + Eliminates the wait time for boiling water, enhancing efficiency.
- **Consistent Water Temperature**
 - + Optimised boiler operation according to water usage, ensuring a stable water temperature without sudden changes.
- **Energy Efficient**
 - + Step-by-step heating gradually heats the water based on demand, avoiding the energy waste of heating an entire tank.
- **Space Saving**
 - + Wall-mounted design saves counter space and provides a sleek, modern look.
- **Safety**
 - + Features dual over-temperature protection to ensure user safety.
- **Easy to use**
 - + Simple lever dispenses instant boiling water.
- **High Capacity**
 - + Suitable for environments with high demand for hot water, with varying capacities to meet different needs.
- **Longer Lifespan**
 - + The step-by-step heating avoids frequent heating and cooling cycles, reducing wear and tear, and extending the lifespan of the water heater.
- **Direct Bottom Inlet Water Heating**
 - + Heating element directly heats the inlet water, providing greater efficiency compared to reheating previously heated water.
- **Copper Tank**
 - + Increases durability and efficiency. Copper tanks heat transfer and more evenly, improving energy efficiency and stable hot-water output. Cooper's antimicrobial and corrosion-resistant properties help keep water hygienic and extend service life.



Applications



Certifications



Dimensions

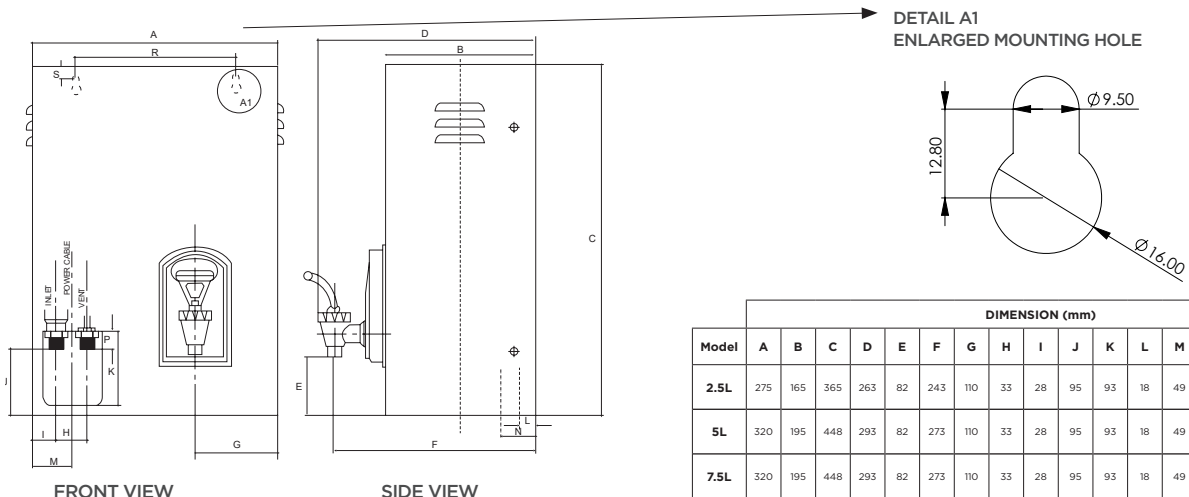

Model	DIMENSION (mm)																
	A	B	C	D	E	F	G	H	I	J	K	L	M	N	P	R	S
2.5L	275	165	365	263	82	243	110	33	28	95	93	18	49	45	20	198	16
5L	320	195	448	293	82	273	110	33	28	95	93	18	49	45	20	198	16
7.5L	320	195	448	293	82	273	110	33	28	95	93	18	49	45	20	198	16

INSTANT BOILING WATER

Instant Boiling Water Dispensers Range Specifications

Model	2.5L	5L	7.5L
Product No.	2850205	2850215	2850225
Application	For the supply of instant boiling water to commercial kitchens, office break rooms, staff kitchens, canteens and hospitality environments.		
Warranty	2 Years	2 Years	2 Years
WaterMark	WM-040339	WM-040339	WM-040339
Storage capacity	2.5L	5L	7.5L
Max. Water Supply Pressure (kPa)	800	800	800
Min. Water Supply Pressure (kPa)	50	50	50
Cold Water Connection	1/2" BSP	1/2" BSP	1/2" BSP
Overflow Vent Connection	1/2" BSP	1/2" BSP	1/2" BSP
Supply Voltage	220 - 240 V AC 50 Hz	220 - 240 V AC 50 Hz	220 - 240 V AC 50 Hz
Electrical Connection	10A 3pin plug	10A 3pin plug	10A 3pin plug
Heating Element (kW)	1.8	2.0	2.0
Approx. Weight Empty (kg)	6.6	8.5	8.7
Approx. Weight Full (kg)	10.7	16.3	18.3
Approx. Time to Heat, to full capacity (mins)	12	15	22
Width (mm)	275	320	320
Height (mm)	365	448	448
Depth (to lever) (mm)	265	293	293



HYDRO SWITCH™ CHANGEOVER VALVE

Hydro Switch™ Rains to Mains Changeover Valve

Economic & efficient automatic changeover valve to enable the use of stored rainwater in household applications such as toilets, laundry, and gardens. Valve smoothly diverts to mains water supply when rainwater storage tank is empty. Ideal for use in domestic and commercial applications with pumps fitted with an auto-restart pressure controller.

- Automatic switchover from rainwater storage tank to mains water supply
- Hydraulic design, with no electrical components
- Low lead brass construction: Withstands harsh weather
- Meets NCC Lead Free requirements
- Suitable as retrofit or upgrade option for other changeover devices
- WaterMark Approved for use with potable water. WMTS 477: 2016 (LN: 021636)

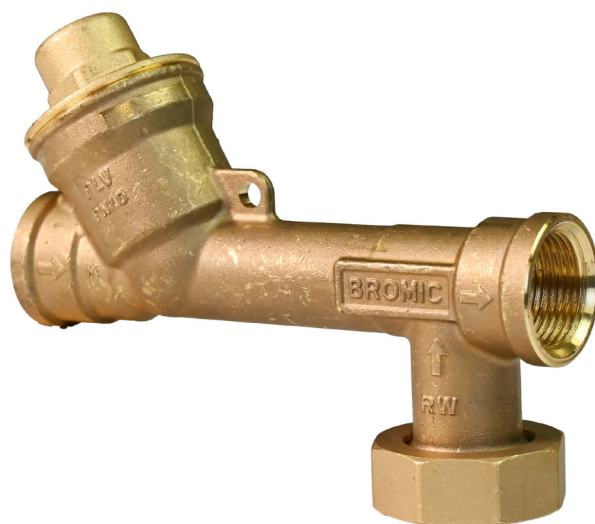

PART No. 7575029
WATERBOY™ HYDRO SWITCH™
RAINS TO MAINS
CHANGEOVER VALVE

Application & Warranty



Compatible Products when connected to Waterboy™ 3kW Controller (Part No. 7575372)

Part No.	Pump Model
7575101	40L Waterboy™ Jet Pump
7575100	60L Waterboy™ Jet Pump

10

Part No.	Max. Mains Pressure	Min. Pump Pressure	Nominal Flow Rate	Water Temp. Range	Recommended Pump Cut-In	IP Rating	Connection Size	
							Inlet	Outlet
7575029	1000 kPa	200 kPa	50 L/min	1° to 40°C	200 kPa	IP55	G 1" G 3/4"	G 3/4"

HYDRO SWITCH™ JET PUMP KITS

Waterboy™ Jet Pump Kits With 1.5kW Controller & Hydro Switch™ Changeover Valve

- Seamless switching between mains water and rainwater with automated horizontal self-priming pump
- Includes heavy duty 1.5kW controller
- Includes Hydro Switch™ automatic changeover valve, WaterMark Approved for use with potable water. WMTS 477: 2016 (LN: 021636)
- Hassle-free automation of water supply
- Quiet operation, ideal for low noise requirement
- Automatic switchover from rainwater storage tank to mains water supply
- Supplied electrical lead suitable for use with any 10 amp power outlet
- For domestic households pressure systems and irrigation
- Reliable stainless steel jet pump in 40L or 60L options
- Rated to IP65



PART No. 7575120-2
WATERBOY™ 40L HYDRO SWITCH™ JET PUMP KIT



PART No. 7575121-2
WATERBOY™ 60L HYDRO SWITCH™ JET PUMP KIT

Application & Warranty



Flow Performance Curves

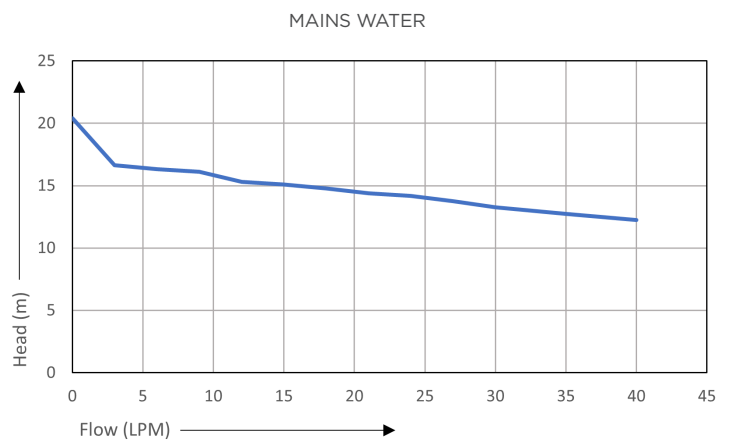
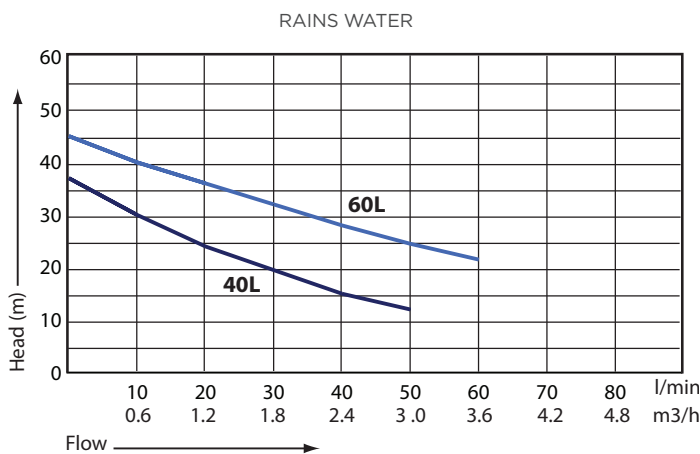

Part No.	Model	Power (kW)	Current 230V/50Hz	Max. Total Head (m)	Rated Head (m)	Rated Flow (m ³ /H)	Connection Size	
							Inlet	Outlet
7575120-2	40L	0.35	2.4A	37	20	1.5	G 1"	G 1"
7575121-2	60L	0.75	5.2A	45	25	2.4	G 1"	G 1"

WATERBOY™ JET PUMPS

Waterboy™ Jet Pumps For use with Clean Water

The Bromic Waterboy™ Jet Pumps offer solutions for domestic household pressure systems and garden irrigation.

- Horizontal pump
- Stainless steel housing
- Ideal for pumping clear water
- Economical and compact
- For use in domestic, irrigation and agriculture



PART No. 7575107
WATERBOY™ 80L JET PUMP

Application & Warranty



PART No. 7575100
WATERBOY™ 60L JET PUMP

Flow Performance Curve

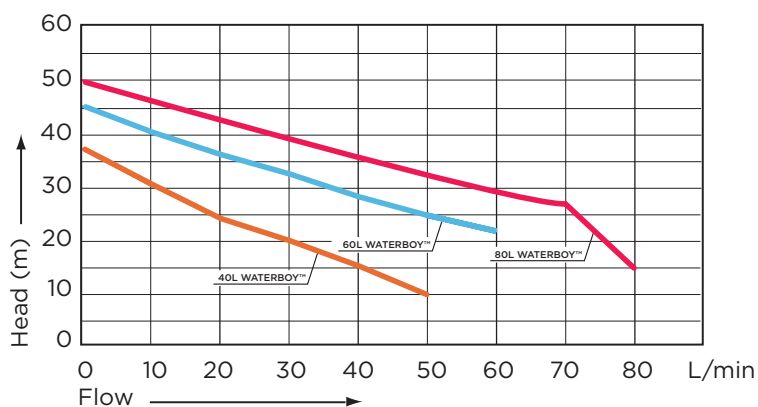

PART No. 7575101
WATERBOY™ 40L JET PUMP

Part No.	Model	Power (kW)	Current 230V/50Hz	Max. Total Head (m)	Rated Head (m)	Rated Flow (m³/H)	Connection Size	
							Inlet	Outlet
7575101	40L	0.37	2.4A	37	20	1.5	G 1"	G 1"
7575100	60L	0.75	5.2A	45	25	2.4	G 1"	G 1"
7575107	80L	1.0	6.2A	50	30	3.0	G 1"	G 1"

Waterboy™ Multi-Stage Pump

The Bromic Waterboy™ Multi-Stage Pump offers solutions for higher pressure applications with quiet and reliable performance.

- Ideal for pumping clear water and non-aggressive liquids
- Comparatively quiet operation
- High efficiency and energy saving
- Stainless steel impeller & chambers
- 6 stage pump

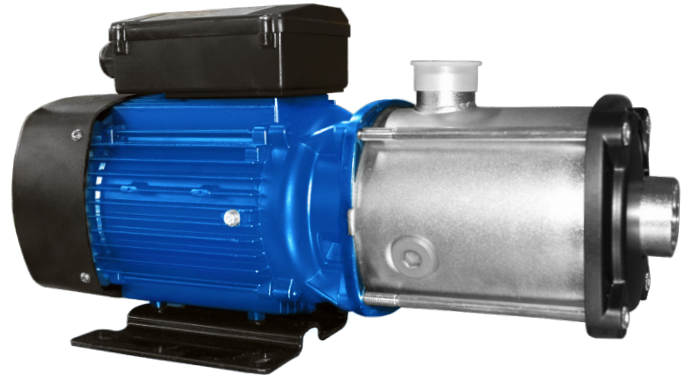

PART No. 7575200
WATERBOY™ MULTI-STAGE PUMP.

Application & Warranty



Flow Performance Curve

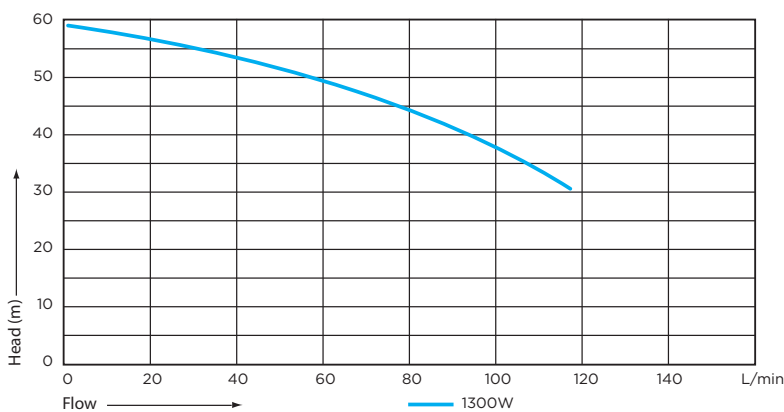

Part No.	Power	Current 230V/50Hz	Max. Total Head (m)	Max. Flow Rate	Connection Size	
					Inlet	Outlet
7575200	1300W	6.8A	58	116L/min	G 1¼"	G 1"

WATERBOY™ PRESSURE CONTROLLER

Waterboy™ Pressure Controller

The Bromic Waterboy 1.5kW Pressure Controller offers complete control of household pumps through hassle-free automation, starting and ceasing water supply in response to demand. With dry-run protection, if the rainwater is depleted, the controller will automatically turn off, preventing damage to the pump from dry-running.

- Suitable for clean water only
- IP65 rated
- Heavy duty 1.5kW controller
- Compatible with any above ground or submersible pump
- Supplied with electrical lead for use with 10 amp power outlet
- 2.2bar cut-in pressure
- Auto restart after power outage
- Dry-run protection
- Auto restart check after dry-run protection



PART No. 7575381
WATERBOY™ 1.5KW
PRESSURE CONTROLLER SERIES 2

Application & Warranty



Compatible Products

Part No.	Pump Model
7575101	40L Waterboy™ Jet Pump
7575100	60L Waterboy™ Jet Pump
7575107	80L Waterboy™ Jet Pump
7575200	116L Waterboy™ Multistage Pump
7575029	Waterboy™ Hydro Switch Rains to Mains Changeover Valve

Available in kits

Part No.	Pump Model
7575105-2	40L Waterboy™ Jet Pump & Controller Series 2
7575106-2	60L Waterboy™ Jet Pump & Controller Series 2
7575108-2	80L Waterboy™ Jet Pump & Controller Series 2
7575210-2	116L Waterboy™ Jet Pump & Controller Series 2
7575120-2	Waterboy™ Hydro Switch 40L Pump back
7575121-2	Waterboy™ Hydro Switch 60L Pump back

Part No.	Supply Voltage	Max. Current AMP	Max. Power	Max. Working Pressure	Cut-in Pressure	IP Rating
7575381	220-240V	10A	1.5kW	10 Bar	2.2 Bar	IP65

CIRCULATION PUMP

Waterboy™ Circulation Pump

- Ideal for Hot Water ring
- 3 adjustable speeds, low power consumption
- Suitable for up to 110°C water temperature
- Stainless steel body and unions
- Thermal protection
- Can be retrofit to existing systems with adaptors included
- For the circulation of hot water in domestic and commercial buildings/systems



PART No. 7575250
WATERBOY™ CIRCULATION PUMP

Application & Warranty



Flow Performance Curve

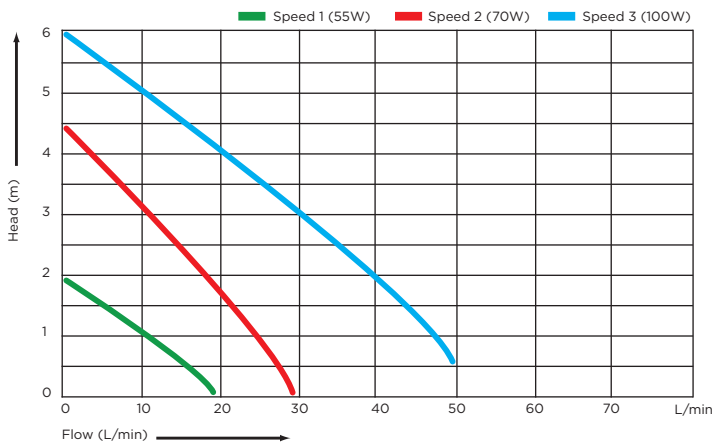

Part No.	Rated Voltage	Power			Motor IP	Water Temp.	Port Spacing	Max. Flow Rate	Max. Head	Connection (with union)	
		100W	70W	55W						Inlet	Outlet
7575250	230V/50Hz	100W	70W	55W	IP44	2° to 110°C	130mm	50L/min	6m	G 3/4"	G 3/4"

SUBMERSIBLE PUMPS

Waterboy™ 800W Submersible Pump with Integrated Controller

- Integrated controller
- Quiet operation
- 2.2 bar cut-in pressure
- Auto restart after power outage
- Dry-run protection
- Auto restart check after dry-run protection
- Electrical safety approval to GMA-514285-EA
- 800W rated power
- For use with clean water only



PART No. 7575134
WATERBOY™ 800W SUBMERSIBLE PUMP
WITH INTEGRATED CONTROLLER

Application & Warranty



Flow Performance Curve

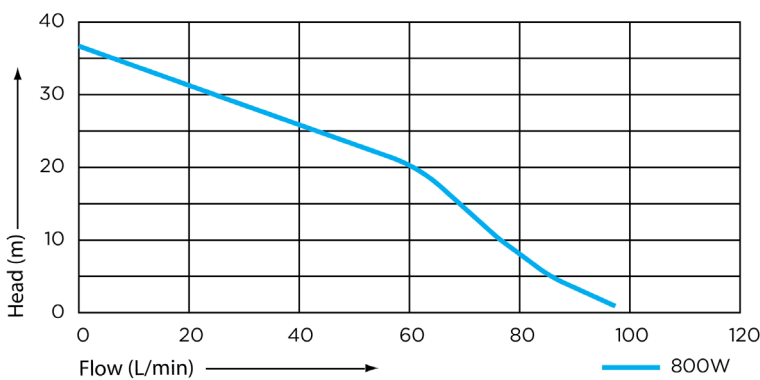

Compatible Hydro Switch Kit

Part No.	Pump Model
7575134-RTM	Waterboy™ 800W Submersible Pump with Integrated Controller & RTM

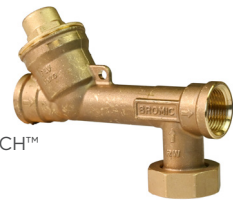

PART No. 7575029
WATERBOY™ HYDRO SWITCH™
RAINS TO MAINS
CHANGEOVER VALVE

Part No.	Rated Voltage	Rated Power	Protection Type	Max. Supply Height	Thread Size
7575134	230V	800W	IPX8	37m	1"
Max. Flow Rate	Max Submersion Depth	Max Liquid Temperature	Max particulate size	Cable Length	Thread Type
100 L/min	7m	35°C	1mm	10m	G

SUBMERSIBLE PUMPS

Waterboy™ Submersible Pump 900W Clean and Dirty Water

- Height-adjustable float switch
- Adjustable water outlet
- High-quality mechanical seal for reliability
- Switch from clean to dirty water applications
- Ideal for emptying ponds, sumps, pits & pool
- Grain size up to 30mm



PART No. 7575126
WATERBOY™ 900W
SUBMERSIBLE PUMP

Application & Warranty



Flow Performance Curves

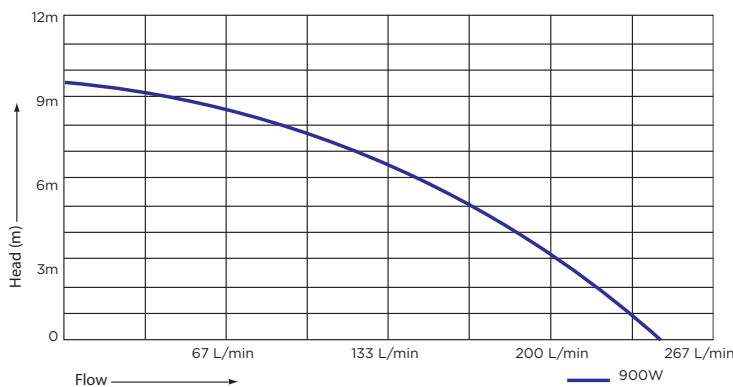

Hose Kit (sold separately)

Suitable for Waterboy™ Submersible Pump

Kit includes:

- Blue PVC Hose - 25mm x 10m
- Nylon Lowering Rope - 10m
- Stainless Steel 25mm Clamp

Part No. 7575129
Waterboy™ Submersible
Pump Hose Kit



Part No.	Rated Voltage/ Frequency	Rated Power	Protection Type	Max. Supply Height	Max. Flow Rate
7575126	230-240V/50Hz	900W	IPX8	8.5m	267 L/min
Max. Submersion Depth	Max. Liquid Temperature	Cable Length	Max. Particulate Size	Pipe Connection	Warranty
5m	35°C	10m	35mm	G Thread Sizes 1", 1 ¼", 1 ½"	2 years

SUBMERSIBLE PUMPS

Waterboy™ Submersible Pump with Vertical Float Switch 750W Dirty Water

- Vertical float switch
- Extremely compact
- Manual / Automatic switch for convenience
- Individually wet tested
- Adjustable water outlet
- High-quality mechanical seal for reliability
- Ideal for emptying ponds, sumps, pits and pools
- 750W rated power

Application & Warranty



PART No. 7575132
WATERBOY™ 750W DIRTY WATER SUBMERSIBLE PUMP
WITH VERTICAL FLOAT

Flow Performance Curve

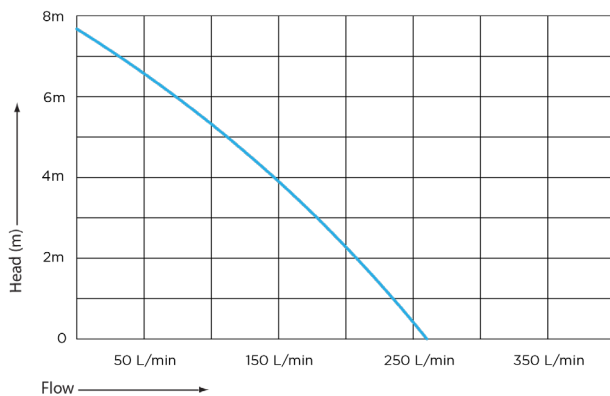

Manual / Automatic Switch

Automatic mode, utilises the integrated float switch.

Manual mode, pump turns on automatically upon cord connection.



Part No.	Rated Voltage	Power Input	Max. Immersion Depth	Max. Particulate Size	Max. Liquid Temp.	Max. Flow Rate	Max. Head	Outlet	Cable Length
7575132	220-240V/50Hz	750W	7m	35mm	35°C	217 L/min	8m	G Thread 1", 1 1/4", 1 1/2"	10m

Waterboy™ 133L Vortex Sump Pump

- Heavy duty cast iron body
- Anti-clog semi-open impeller for easy maintenance and long service life
- Built-in thermal cutoff device with auto-reset function to ensure long service life
- Harmonized H07RNF rubber flexible multicore cable, designed to withstand weather, UV, and oil
- Stainless steel motor shaft and housing
- Handles soft solids up to 15mm in size
- Ideal for grey water pumping, sump emptying, septic effluent pumping, and water transfer
- IP68 rated

Application & Warranty



PART No. 7575150
WATERBOY™ SUBMERSIBLE PUMP
VORTEX SUMP PUMP

Flow Performance Curve

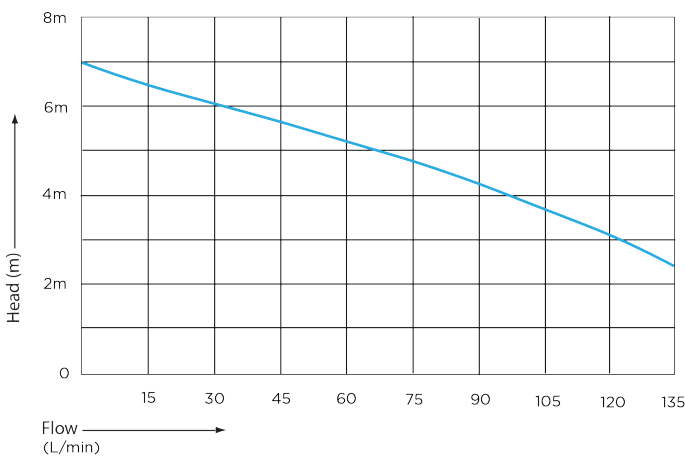

Part No.	Rated Power Input	Max. Immersion Depth	Max. Solid Size	Max. Flow Rate	Max. Head	Outlet	Power Cable Length
7575150	340W	5m	15mm	133L/min	7m	G Thread Sizes 1", 1 1/4", 1 1/2"	10m

VORTEX PUMPS

Waterboy™ 300L Vortex Submersible Pump

- Heavy duty cast iron body
- Anti-clog semi-open impeller for easy maintenance and long service life
- Harmonized HO7RNF rubber flexible multicore cable, designed to withstand weather, UV, and oil
- Built-in thermal cutoff device with auto-reset function to ensure the long service life
- Handles soft solids up to 25mm in size
- Stainless steel motor shaft and housing
- Ideal for grey water pumping, sump emptying, septic effluent pumping, and water transfer
- 1100W rated power

Application & Warranty



PART No. 7575155
WATERBOY™ 300L VORTEX
SUBMERSIBLE PUMP

Flow Performance Curve

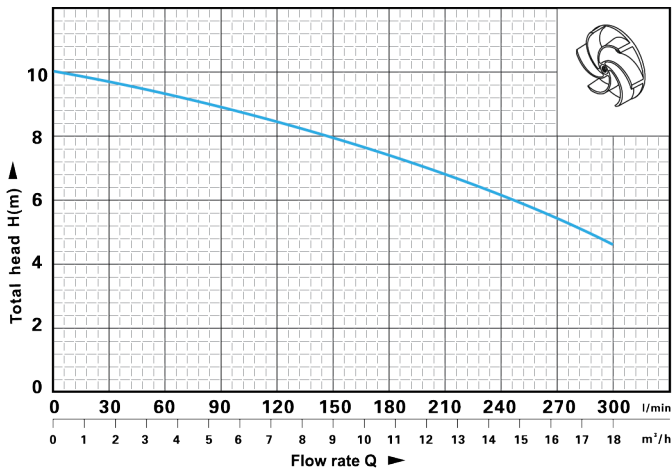

Part No.	Max. Flow Rate	Rated Power Input	Max. Immersion Depth	Max. Solid Size	Max. Head	Outlet	Power Cable Length
7575155	300L/min	1100W	5m	25mm	10m	G 2"	10m

Waterboy™ 270L Cutter Submersible Pump

- Heavy duty cast iron body
- Durable 7Cr17 cutting mechanism easily cuts various materials
- Anti-clog semi-open impeller for easy maintenance and long service life
- Harmonized HO7RNF rubber flexible multicore cable, designed to withstand weather, UV, and oil
- Built-in thermal cutoff device with auto-reset function
- Dual Ceramic/Graphite mechanical seal
- Stainless steel motor shaft and housing
- Ideal for grey and black water pumping, sump emptying, septic effluent and sewage disposal, and pumping of waste water with soft solids in suspension
- 1500W rated power



PART No. 7575170
WATERBOY™ 270L CUTTER
SUBMERSIBLE PUMP

Application & Warranty



Flow Performance Curve

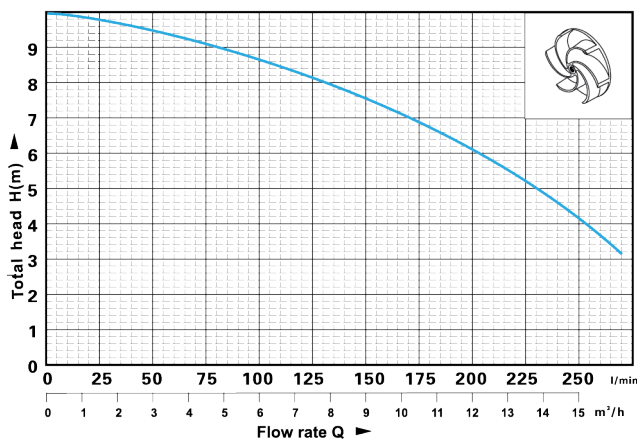

Cutting Mechanism

7Cr17
High Carbon
Stainless Steel
Cutting Device



Part No.	Rated Voltage	Power Input	Max. Immersion Depth	Max. Liquid Temperature	Max. Flow Rate	Max. Head	Outlet	Cable Length
7575170	220-240V/50Hz	1500W	5m	40°C	270L/min	10m	G 2"	10m

SEWAGE PUMPS

Waterboy™ 250L Grinder Submersible Pump

- Heavy duty cast iron body
- Durable 9Cr18 cutting mechanism easily shreds various materials
- Anti-clog semi-open impeller for easy maintenance and long service life
- Harmonized H07RNF rubber flexible multicore cable, designed to withstand weather, UV, and oil
- Built-in overcurrent & thermal cutoff device with auto-reset function to ensure the long service life
- Dual Ceramic/Graphite mechanical seal
- Stainless steel motor shaft and housing
- Ideal for grey and black water pumping, sump emptying, septic effluent and sewage disposal, and pumping of waste water with soft solids in suspension
- 1650W rated power



PART No. 7575127
WATERBOY™ SUBMERSIBLE PUMP
50L CLEAN WATER

Application & Warranty



Flow Performance Curve

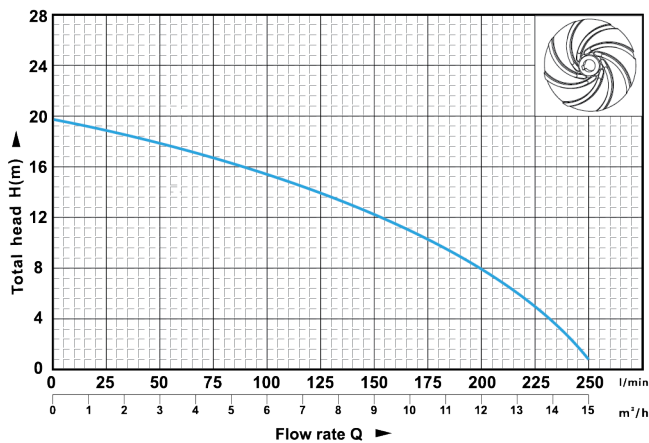

Cutting Mechanism

9Cr18
High Carbon
Stainless Steel
Cutting Device

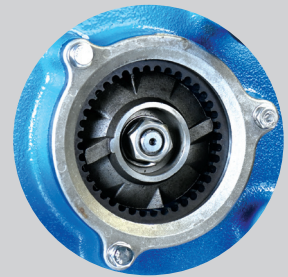

Part No.	Rated Voltage	Power Input	Max. Immersion Depth	Max. Liquid Temperature	Max. Flow Rate	Max. Head	Outlet	Cable Length
7575180	220-240V/50Hz	1650W	5m	40°C	250L/min	19.5m	G 2"	10m

WATER HOSE SPECIFICATION DETAILS

Water hose assembly is for indoor use only and to be installed away from UV light.

It is the responsibility of the installer to ensure the suitability of the water connector for the application and to ensure compliance with any government health codes and regulations.

Bromic water connectors are not to be installed within cavities, below ground or in any other inaccessible locations.

When installing, please ensure all threads and sealing surfaces are clean and dry. The installer must ensure all threads and sealing faces are de-burred and undamaged. Ensure the hose is not subject to abrasion and that the hose is not exposed to caustic or corrosive substances during installation (e.g. solder flux) and over the life of the product (e.g. cleaning products). Exposure to caustic or corrosive substances will void the Bromic warranty.

Refer to the hose label for the tightening requirements of the connector. Ensure not to over tighten the connector. The connector is also subjected to tensile or compressive force and must not be twisted or kinked.

During the installation the water hose assembly is to be installed free from kinks and excessive tight bends. For minimum bend radius (see Table 1). When installing the connector, ensure the bend radius is as large as possible where movement is possible.

DESCRIPTION			MINIMUM BEND RADIUS (EPDM Hose)					
ID mm	Max: Pressure (MPa)	Temperature	R	A	D (OD)	B	Z a=90°	Z a=180°
8	1.4	5°C to 70°C	25	25	13	20	140	190
10	1.4	5°C to 70°C	30	30	15	21.5	165	220
19	1.4	5°C to 70°C	55	5	27.5	35	290	396

Table 1: EPDM Hose installation requirements

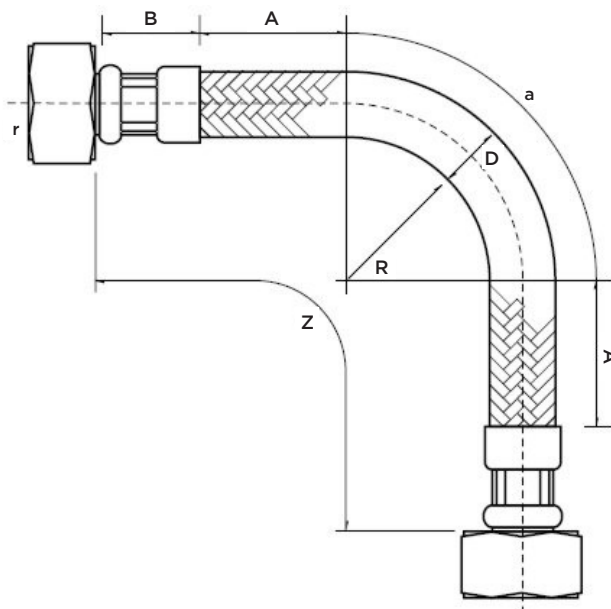

FLEXPRO WATER HOSES

FLEXPRO Water Hoses

Engineered with performance, safety and ease of installation in mind, the FLEXPRO™ PE-RT ACB Water Hose sets a higher standard for professional plumbing. Made from next-generation materials and precision construction, FLEXPRO™ delivers industry-leading flexibility, temperature tolerance and chemical resistance which means you can count on it even in the toughest conditions. It's flexible, durable, and built to outperform metal-reinforced alternatives on safety and reliability.

The maximum working conditions for Bromic FLEXPRO™ Water Hoses connectors are as follows:

- Heated water +90°C @ 1400kPa
- Cold-water supplies 1400 kPa
- Rated working pressure not to exceed 1400kPa

Certifications



8mm FLEXPRO ACB PERT Water Hose - 8WRB

Part No.	Description	Length	Box Qty
8WRB0225	1/2" G FC x 1/2" G FC ACB Pert Water Hose	225mm	200
8WRB0300		300mm	200
8WRB0450		450mm	150
8WRB0600		600mm	100



QUICKY HOSE	PEX PRO	FLEX PRO
<p>8WEB EPDM SS304 braid Low lead compliance</p>	<p>8WSB PEX liner SS316 braid Low lead compliance</p>	<p>8WRB PE-RT liner ACB braiding Low lead compliance</p>
<p>BENEFITS</p> <ul style="list-style-type: none"> ✓ Everyday value option ✓ Flexible hose (easy for install) 	<p>BENEFITS</p> <ul style="list-style-type: none"> ✓ Burst proof PEX inner ✓ SS316 braid rust proof ✓ 15-year warranty 	<p>BENEFITS</p> <ul style="list-style-type: none"> ✓ Burst-proof PE-RT liner ✓ ACB nylon braid ✓ 15-year warranty ✓ Ultra-flexible design ✓ Rust-proof ✓ Kink-proof
<p>STANDARD Everyday installs</p> <ul style="list-style-type: none"> + EPDM liner core + SS304 braid + Suitable for everyday plumbing applications <p>1yr WARRANTY</p>	<p>ENHANCED High reliability installs</p> <ul style="list-style-type: none"> + Burst-proof construction + Rust-proof design + Built for long-term reliability <p>15yr WARRANTY</p>	<p>ADVANCED High-performance installs</p> <ul style="list-style-type: none"> + Burst-proof construction + Ultra-flexible, kink-free design + Rust-proof + Ideal for tight or high-movement installs <p>15yr WARRANTY</p>

PEX CORE WATER HOSES

PEX PRO Water Hoses

Bromic 8mm PEX PRO™ water hoses are burst proof & rust proof! Manufactured with our extremely high-density polyethylene PEX inner core, covered with a marine grade 316 stainless steel braid that is highly resistant to rust and corrosion. PEX PRO™ hoses meet the highest mechanical and hygiene standards, and are backed by an industry leading 15yr warranty.

The maximum working conditions for Bromic PEX PRO™ Water Hoses connectors are as follows:

- Heated water +70°C @ 1000kPa
- Cold-water supplies 1200 kPa
- Rated working pressure not to exceed 1400kPa

Certifications



8mm PEX PRO Braided Stainless Steel Straight Water Hose - 8WSB

Part No.	Description	Length	Box Qty
8WSB0150-1	1/2" F x 1/2" F Straight PEX Core Water Hose	150mm	25
8WSB0225-1		225mm	25
8WSB0300-1		300mm	25
8WSB0450-1		450mm	25
8WSB0600-1		600mm	25
8WSB0750-1		750mm	25
8WSB1000-1		1000mm	25
8WSB1500-1		1500mm	25

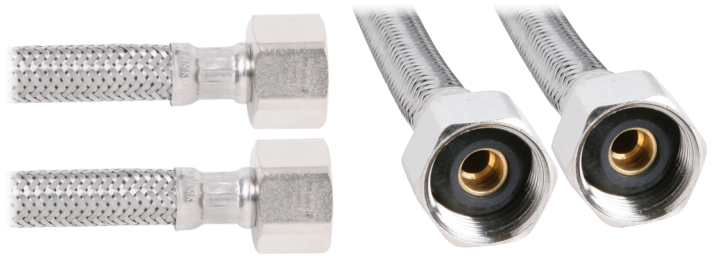

8mm PEX PRO Braided Stainless Steel Elbow Water Hose - E8WSB

Part No.	Description	Length	Box Qty
E8WSB0150-1	1/2" F x 1/2" F Elbow PEX Core Water Hose	150mm	10
E8WSB0225-1		225mm	10
E8WSB0300-1		300mm	25
E8WSB0450-1		450mm	25
E8WSB0600-1		600mm	10
E8WSB0750-1		750mm	10

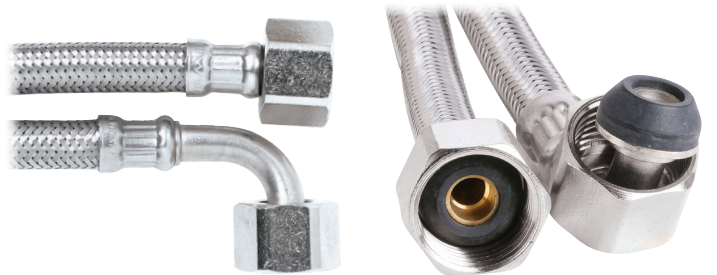

PEX CORE MIXER TAP HOSES

PEX Mixer Tap Hoses

Bromic 8mm PEX core water hoses are manufactured with our high-density polyethylene PEX inner core covered with a stainless steel braid. WaterMarked in accordance with AS 3499, PEX hoses are more durable than standard EPDM hoses and meet the highest mechanical and hygiene standards, backed by a 10yr warranty.

The maximum working conditions for Bromic PEX Water Hoses connectors are as follows:

- Heated water +70°C @ 1000kPa
- Cold-water supplies 1200 kPa
- Rated working pressure not to exceed 1400kPa

Certifications



8mm PEX Core Braided Stainless Steel Water Hose Mixer Kit - 8WMF

Part No.	Description	Length	Box Qty
8WMF0150-1	1/2" F x 1/2" M PEX Core Mixer Tap Extension Kit	2x150mm	10 pairs
8WMF0225-1		2x225mm	10 pairs



8mm PEX Core Braided Stainless Steel Cold Mixer Tap Hose - 8WPM COLD

Part No.	Description	Length	Box Qty
8WPM0350C-1	1/2" F x M10 Cold PEX Core Mixer Tap Hose	350mm	25
8WPM0500C-1		500mm	25



8mm PEX Core Braided Stainless Steel Hot Mixer Tap Hose - 8WPM HOT

Part No.	Description	Length	Box Qty
8WPM0350H-1	1/2" F x M10 Hot PEX Core Mixer Tap Hose	350mm	25
8WPM0500H-1		500mm	25



8mm PEX Core Braided Stainless Steel Mixer Tap Hoses - 8WPM PAIR (1x HOT & 1x COLD)

Part No.	Description	Length	Bag Qty
8WPM0350P-1	1/2" F x M10 Hot PEX Core Mixer Tap Hoses (1x Hot & 1x Cold)	350mm	5
8WPM0500P-1		500mm	5



Quicky Water Hoses

Bromic 'Quicky' stainless steel braided EPDM water hoses are manufactured with a rubber core covered with a stainless steel braid. WaterMarked in accordance with AS 3499, these hoses are backed by a 1-year warranty.

The maximum working conditions for Bromic EPDM Water Hoses connectors are as follows:

- Maximum working temperature +70°C
- Maximum working pressure 1400 kPa

Certifications



8mm 'Quicky' Braided Stainless Steel Water Hose - 8WEB

Part No.	Description	Length	Box Qty
8WEB0225-1	1/2" F x 1/2" F Straight Connector	225mm	25
8WEB0300-1		300mm	25
8WEB0450-1		450mm	25
8WEB0600-1		600mm	25

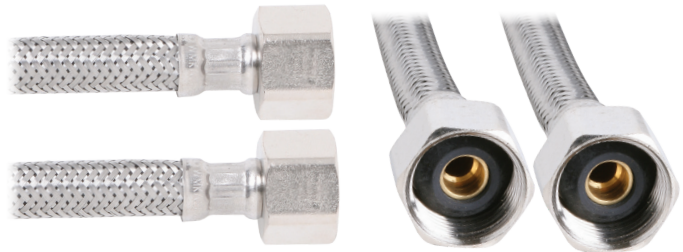

19mm 'Quicky' Braided Stainless Steel Water Hose - 19WBB

Part No.	Description	Length	Box Qty
19WBB0300-1	3/4" F x 3/4" F Straight Connector	300mm	10
19WBB0450-1		450mm	10
19WBB0600-1		600mm	10
19WBB1000-1		1000mm	10

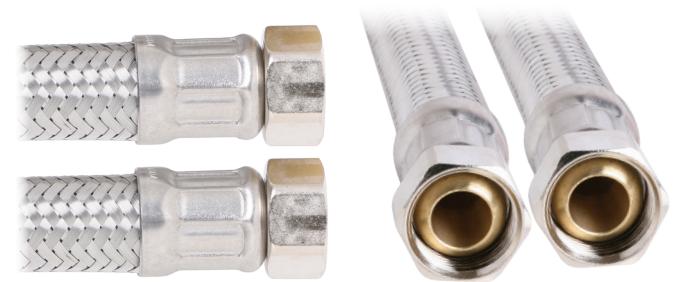

19mm 'Quicky' Braided Stainless Steel Water Hose - 19WBF

Part No.	Description	Length	Box Qty
19WBF0500-1	3/4" F x 3/4" F Flat Washer	500mm	10
19WBF1000-1		1000mm	10
19WBF1500-1		1500mm	10

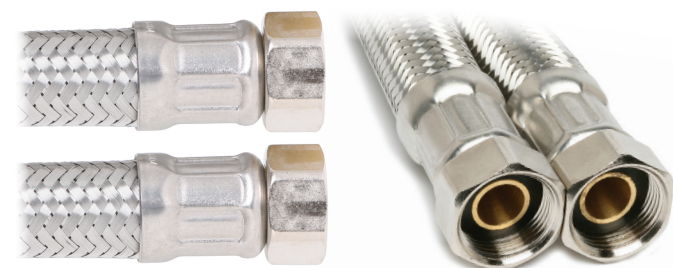

Air Admittance Valve with Adaptor for 32-40-50mm

Part No. 1210701

Bromic Magic Valves are air admittance valves designed to remove the need for roof penetration whilst protecting trap seal.

- Saves the need to penetrate the outlet roof shell
- Saves on the cost of pipe and expensive fittings
- Saves on roof flashing
- Saves on labour costs
- Prevents the loss of water from trap seals and consequent release of foul air into the building
- WaterMark approved WM-040105



Certifications

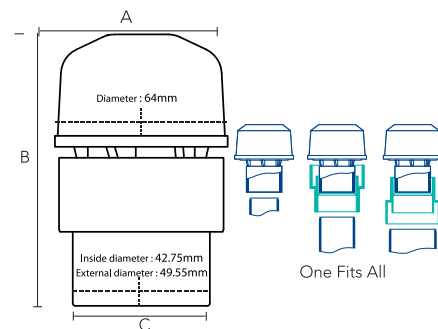

Specifications	MV32
Part No.	1210701
Airflow capacity (L/sec)	10.1
Temperature range	-20 to +60°C
A	64mm
B	32mm connection = 83 mm 40mm connection = 104 mm 50mm connection = 120 mm
C	32mm connection = 43 mm 40mm connection = 50 mm 50mm connection = 61 mm
Connection	32mm, 40mm and 50mm Solvent Cement
Maximum Unit Loading	Up to 172 fixture units for discharge pipes and 10 fixture units for discharge stacks

Typical Domestic Discharge System

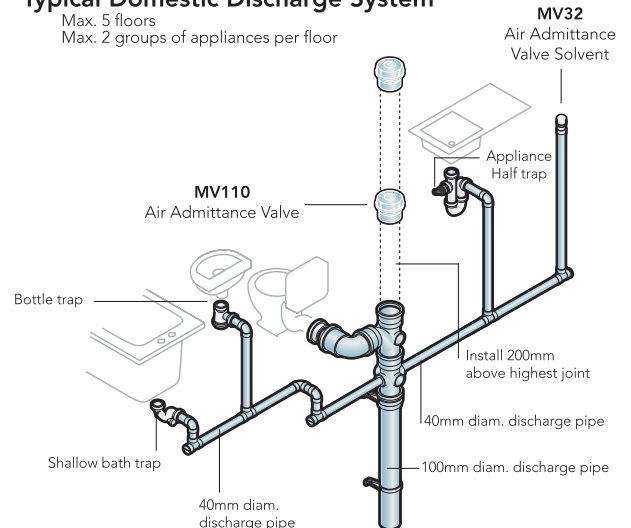

^All Bromic products are manufactured to the highest quality standard and come with guarantees against any material or workmanship defects; guarantees that cannot be excluded under Australian Consumer Law. For specific warranty details on any of our products, including warranty duration, please refer to the product instructions. Alternatively, you can contact one of our helpful customer service staff or visit bromicplumbing.com for more information.

IMAGES, SPECIFICATIONS

Due to the nature of the printing process, colours shown in this catalogue may differ from the actual colour of products. All images, drawings, graphics and design elements contained in this catalogue are subject to Australian and International copyright law. No part of this catalogue may be reproduced, copied or stored in part or whole without the prior written permission of Bromic Pty Ltd. Product details in this guide are indicative only and may change without notice, Bromic reserves the right to change specifications and any other information contained in this catalogue with no recourse from customers.

ORDERING

Orders can be placed by fax, online or email. Our catalogue includes Part No. to ensure ease of use, with the customer in mind.

COMPLIANCE

Products stocked by Bromic comply with all relevant regulatory requirements i.e. MEPS, AGA, electrical and safety requirements.

Australia & NZ

10 Phiney Place, Ingleburn
NSW 2565 Sydney AUSTRALIA

Visit **BROMICPLUMBING.COM**
email **plumbing@bromic.com**
or call **AU 1300 276 642 / NZ 0508 276 642**

